

MODEL 6634C
VIBRATION AMPLIFIER
**INSTRUCTION
MANUAL**

Legacy Product Not For Sale

Endevco®

IM6634C

Revision G
Sept 2019

**ENDEVCO 6634C
INSTRUCTION MANUAL**

TABLE OF CONTENTS

<u>SECTION 1: INTRODUCTION</u>	<u>PAGE</u>
1. INTRODUCTION	1-1
2. CONFIGURATION	1-1
3. ELEMENTARY THEORY	1-2
4. PERFORMANCE DATA AND SPECIFICATIONS	1-4
<u>SECTION 2: UNPACKING AND CHECKOUT</u>	
1. INTRODUCTION	2-1
2. UNPACK	2-1
3. INSTALL OPTION BOARDS	2-1
4. SET JUMPERS	2-2
5. POWER UP	2-2
6. CHECKING OUT UNIT	2-2
7. CONNECTIONS	2-4
8. ACCESSORY LIST	2-7
9. JUMPER CONFIGURATION	2-8
<u>SECTION 3: OPERATING INSTRUCTIONS</u>	
1. KEYBOARD AND DISPLAY	3-1
2. NORMAL MODE	3-1
3. INPUT SETTINGS	3-2
4. OUTPUT AND DISPLAY SETTINGS	3-4
5. PROGRAMMABLE FILTER	3-5
6. ALARM	3-6
7. STORE/RECALL SETTINGS, KEYBOARD LOCKUP, AND BUS ADDRESS	3-6
8. EXTERNAL CALIBRATION	3-7
<u>SECTION 4: OPERATION WITH RS-232 INTERFACE</u>	
1. OVERVIEW AND COMMAND FORMAT	4-1
2. INPUT SETTINGS	4-3
3. OUTPUT SETTINGS	4-4
4. PROGRAMMABLE FILTER	4-6
5. ALARM	4-8
6. EXTERNAL CALIBRATION	4-9

**ENDEVCO 6634C
INSTRUCTION MANUAL**

TABLE OF CONTENTS (continued)

<u>SECTION 4: OPERATION WITH RS-232 INTERFACE (continued)</u>		<u>PAGE</u>
7.	STORE AND RECALL SETUPS	4-10
8.	STATUS	4-10
9.	ASCII CHARACTER SET TABLE	4-12
 <u>SECTION 5: MAINTENANCE</u>		
1.	ROUTINE MAINTENANCE AND HANDLING	5-1
2.	VERIFYING AND EXCHANGING FAULTY ASSEMBLIES	5-1
3.	REPLACING EPROMS	5-2
 <u>APPENDIX A: DETAILED THEORY OF OPERATION</u>		
1.	AMPLIFICATION	A-1
2.	RCC/ISOTRON OPERATION	A-2
3.	SIGNAL FILTERING	A-5
4.	ANALOG-TO-DIGITAL CONVERSION CIRCUITY	A-5
5.	PHASE RESPONSE FOR 6634C	A-6
6.	INTERFACE TO 6726 TRACKING FILTER	A-7
7.	INTERFACE WITH 6634A INSTALLATIONS	A-8
 <u>LIST OF ILLUSTRATIONS</u>		
1-1	MODEL 6634C INPUT/OUTPUT DIAGRAM	1-2
1-2	SIMPLIFIED BLOCK DIAGRAM OF THE MODEL 6634C	1-4
2-1	WIRING DIAGRAM FOR INPUT AND OUTPUT CONNECTORS	2-6
2-2	SERIAL INTERFACE CABLE CONNECTOR PINOUTS	2-7
2-3	INPUT/OUTPUT CONNECTOR PINOUTS	2-8
2-4	JUMPER LOCATIONS ON MAIN BOARD	2-9
3-1	KEYBOARD DIAGRAM OF MODEL 6634C	3-2
5-1	EPROM LOCATION ON MAIN BOARD	5-3
A-1	SIMPLIFIED BLOCK DIAGRAM OF THE MODEL 6634C	A-3
A-2	SIMPLIFIED SCHEMATIC OF RCC/ISOTRON CIRCUITRY	A-4
A-3	RCC/ISOTRON FREQUENCY RESPONSE NOMOGRAPH	A-4
A-4	DIGITAL SIGNAL FLOW DIAGRAM	A-6
A-5	PHASE RESPONSE FOR 6634C	A-7

ENDEVCO 6634C INSTRUCTION MANUAL

SECTION 1: DESCRIPTION

1. INTRODUCTION

The ENDEVCO Model 6634C Vibration Amplifier, shown in Figure 1-1, is a microprocessor-based signal conditioning instrument designed to condition and display accelerometer signals in vibration testing of rotating machines.

The 6634C-X Vibration Amplifier is a single channel instrument which operates from one of the following Input Sources:

- External Calibration Source
- Single Ended Piezoelectric (PE) Accelerometer
- Differential PE Accelerometer

The 6634C produces the following Output Signals (English units, as provided by the Model 6634C-E, are shown; Metric units are provided by the Model 6634C-M):

- Broadband acceleration output
- Acceleration Output (fixed at 50 mV/g pk)
- Velocity Output (fixed at 100 mV/ips pk)
- Displacement Output (fixed at 200 mV/mil pk-pk)
- AC Programmable Output can be set to:
 - Acceleration - 2g pk to 200 g pk, Full Scale
 - Velocity - 1.0 ips pk to 100 ips pk, Full Scale
 - Displacement - 0.5 mils to 50 mils pk-pk, Full Scale
- DC Programmable Output can be set to:
 - Acceleration - 2g pk to 200 g pk, Full Scale
 - Velocity - 1.0 ips pk to 100 ips pk, Full Scale
 - Displacement - 0.5 mils to 50 mils pk-pk, Full Scale

The DC Output can also be programmed to represent true-RMS, average, or peak (pk-pk for displacement). Two TTL compatible latched alarm outputs, triggered if the DC output exceeds pre-programmed levels. The DC and AC Full Scale Outputs can be independently set to 1V, 5V, or 10V by internal jumpers.

The 6634C provides the following front panel Displays:

- Digital Display of DC Output in Engineering Units
- LED Display of Engineering Units in Effect
- LED Display of Alarm Status
- Digital Display of OL representing overload of AC or DC output

2. CONFIGURATION

The 6634C is a line-powered, single-channel instrument which may be used independently or up to 6 units may be mounted in an optional 19" rack (Endevco P/N 4948, 5" high). All signal and power connections are made at the rear panel of the unit.

**ENDEVCO 6634C
INSTRUCTION MANUAL**

The Vibration Amplifier is powered by 45 to 440 Hz AC input power:

90 - 240 VAC Model 6634C (internal switch selectable)

The performance capabilities of the 6634C can be expanded by adding the following options:

- Programmable Six-Pole Filter Model 35840A
- Serial Interface Board Model 35843

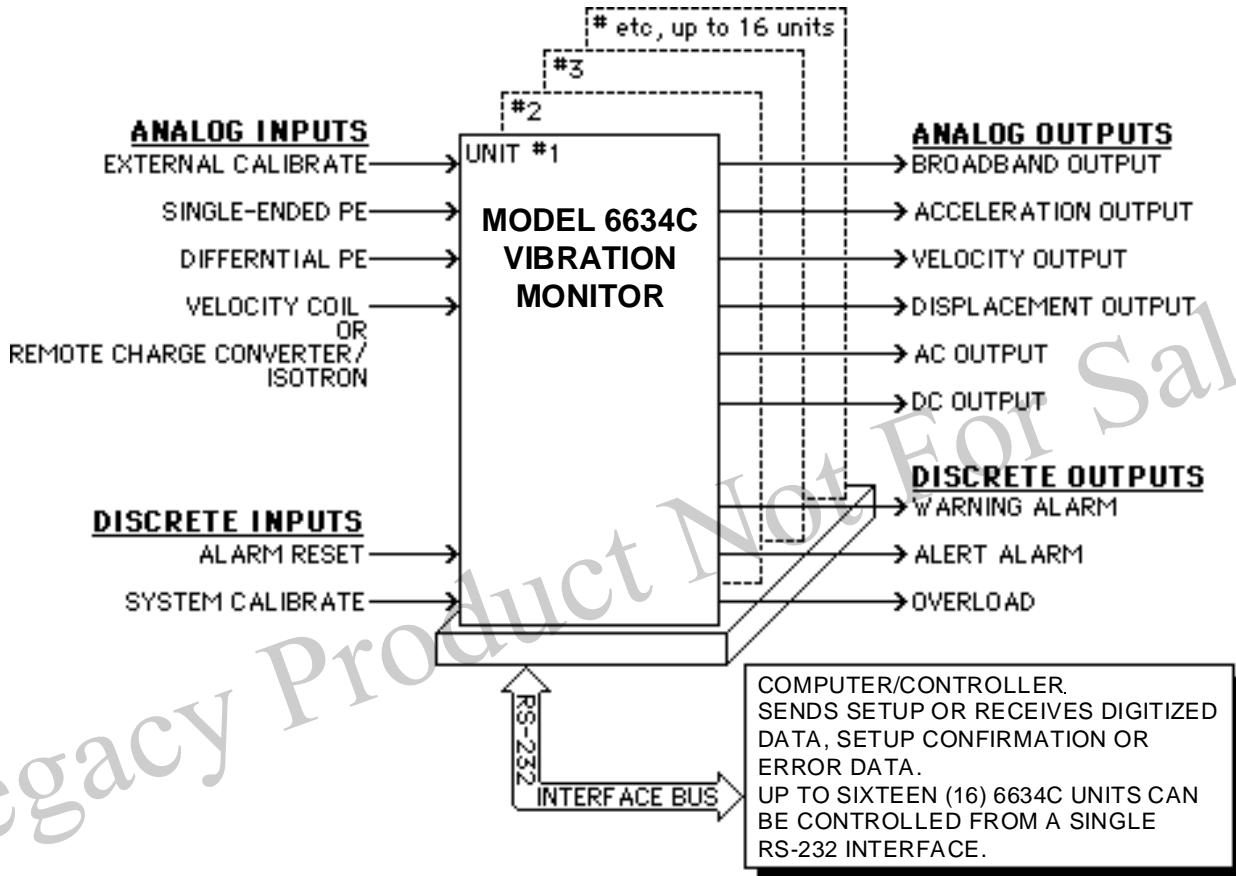

Figure 1-1: Model 6634C Input/Output Diagram.

3. ELEMENTARY THEORY

The ENDEVCO Model 6634C Vibration Amplifier is a single-channel signal conditioner and display instrument which provides a wide range of modes and settings, selected by the operator from the front panel or from a controller/computer via an RS-232 bus (optional), and which are set, verified, and monitored by an internal microprocessor.

The ENDEVCO Model 6634C is a programmable signal conditioner providing a number of types of output, as well as a front panel digital display. The internal microprocessor sets up all the operating parameters in response to commands input at the front panel keyboard or to ASCII string commands transmitted over the RS-232 bus from a controller/computer (with the optional Model 35843 Serial Interface Board installed).

ENDEVCO 6634C INSTRUCTION MANUAL

Figure 1-2 shows a simplified circuit of the Model 6634C. The optional Serial Interface, Six-Pole Programmable Filter input (Model 6634C-XSF) are shown installed.

A. INPUTS

The Model 6634C accepts inputs from:

- External Calibration Source
- Single-ended piezoelectric (PE) accelerometer
- Differential PE accelerometer
- Velocity Coil transducer (6634C), or jumper-selectable between Velocity Coil transducer and Remote Charge Converter (6634C)

The Remote Charge Converter (RCC) input provides a constant current source to power Remote Charge Converter electronics or Isotron accelerometers. The External Calibration input provides for inserting an externally supplied signal for system gain verification and calibration.

B. AMPLIFIERS AND FILTERS

The PE inputs (and the Ext Cal input) are amplified by a fixed-gain charge amplifier. The Velocity Coil input is amplified by a fixed-gain instrumentation amplifier. The Remote Charge Converter input is amplified by the fixed-gain voltage amplifier. Programmable switches configure these input stages to deliver the desired amplified signal to the Sensitivity Amplifier. This stage is programmed to normalize the signal for the sensitivity of the sensor. This normalized signal is delivered to the Broadband Output and can be filtered in the optional Six-Pole Filter or routed directly to the next stages. The corner frequency of the optional Six-Pole Filter is programmable from the front panel or over the RS-232 bus (with the optional Serial Interface). The External Filter can be used with or without the programmable filter installed. (See Section 4.4.C)

C. INTEGRATORS AND ANALOG OUTPUTS

The filtered or unfiltered output can be integrated once (to provide velocity data) or twice (to provide displacement data). The filtered or unfiltered signals are delivered to the Accel-Out, Vel-Out, and Disp-Out Outputs. One of these signals is switch-selected to be routed to the programmable gain Range Amplifier. The output of the Range Amplifier is amplified in the fixed-gain AC Output Amplifier and delivered to the AC-Output. The Full-Scale amplitude of the AC-Output can be set to 1V pk, 5V pk, or 10V pk using internal jumpers.

D. DIGITAL OUTPUTS AND DISPLAY

The RMS value of the Range Amplifier output is converted to DC, which is then converted to 10-Bit digital data in the A/D Converter. The microprocessor converts that data into engineering units and sends the value to the front panel display. This same value is converted to an analog signal in the D/A Converter, amplified in the fixed gain DC Output Amplifier, and delivered to the DC-Output. The Full-Scale amplitude of the DC-Output can be set to 1V, 5V, or 10V using internal jumpers.

E. ALARMS

The digital amplitude data is compared to two pre-programmed alarm levels, and the microprocessor generates a Warning Alarm and/or an Alert Alarm when the appropriate level is exceeded. In addition, the microprocessor generates an Overload Alarm if the input to the A/D Converter (or any of the preceding amplifiers) exceeds the saturation level for more than 3 seconds.

**ENDEVCO 6634C
INSTRUCTION MANUAL**

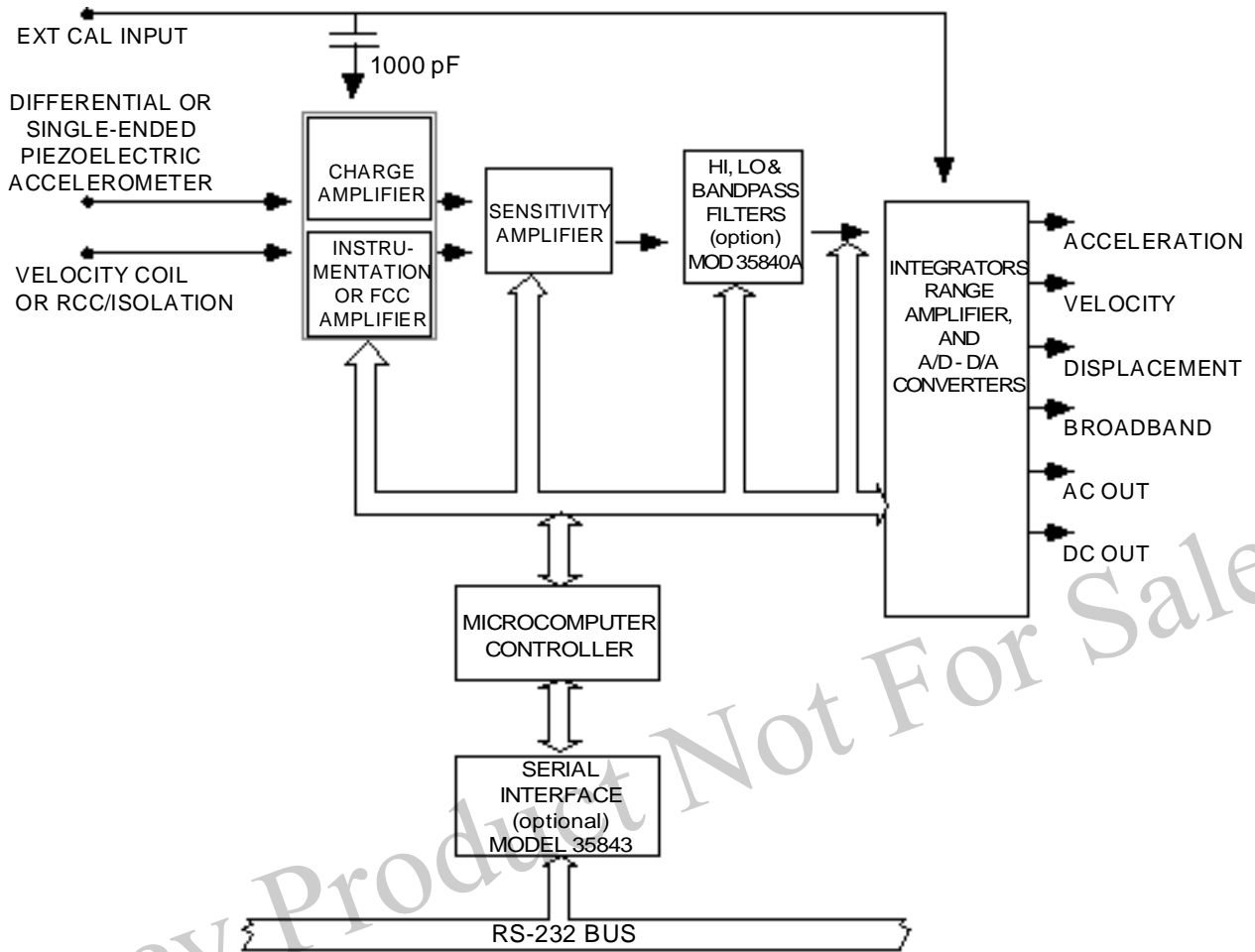

Figure 1-2: Simplified block diagram of the Model 6634C. Settings are implemented by keyboard inputs or through software commands over the RS-232 bus.

4. PERFORMANCE DATA AND SPECIFICATIONS

A Data Sheet and set of current Specifications are provided which define the expected limits of performance for the Model 6634C.

ENDEVCO 6634C INSTRUCTION MANUAL

SECTION 2: UNPACKING AND CHECKOUT

1. INTRODUCTION

Unpack and check for all items in shipment, install optional boards, and power-up.

The ENDEVCO Model 6634C Vibration Amplifier is normally shipped in a single box containing the Model 6634C with the ordered X (English/Metric) choices installed. The power cable, mating multi-pin connectors, and manual are also packed in this box. Option boards are shipped in individual packages. Option boards will be installed in the amplifier if ordered as a system.

2. UNPACK

The equipment has been inspected and tested at the factory, and is ready for operation when received. Inspect for damage during shipment. Carefully open the box and inspect each item for signs of damage. Report any obvious damage to the carrier, immediately. If the shipping container or cushioning material is damaged, it should be kept until the contents of the shipment have been checked mechanically and electrically. In any case, save the packing materials for future shipments of the hardware. Check each item of the shipment against the included packing list. Notify ENDEVCO of any discrepancy.

Unwrap the Model 6634C and set on a level, firmly supported surface. The unit contains a built-in power supply. No cooling fan is required. There is no power switch, and the unit derives its power from the rear power cable connector. The line voltage selection switch is inside the unit, and should be checked to ensure that it is correctly set.

WARNING: REMOVE POWER CORD FROM UNIT BEFORE OPENING CASE TO PREVENT ELECTRICAL SHOCK.

3. INSTALL OPTION BOARDS

Optional boards may be installed by the user or at the factory. CARE MUST BE TAKEN when unwrapping and handling the plug-in cards to avoid electrostatic discharge (ESD) which may damage sensitive components.

WARNING: HANDLE UNWRAPPED CARDS ONLY AFTER GROUNDING YOUR BODY WITH AN ESD DEVICE, SUCH AS A GROUNDED WRIST STRAP.

Unpack the option board and unwrap it from its anti-static wrapping. Install the Model 35840A Programmable Six-Pole Filter Board by plugging board (component side down) into multi-pin connector (P8) located on upper edge of main board, just behind the power supply module (See Figure 2-4). Install the Model 35843 Serial Interface Board by plugging board (component side up) into multi-pin connector (P7) located on lower edge of main board, midway between power supply module and front panel. In either case, secure board by installing the supplied screws into brackets in option board (two per board). For the Model 35843 board, mount remote RS-232 connector to back panel and route wiring below power supply module. Observe any instructions provided with Optional Board.

NOTE: External Calibration must be performed after installing Programmable Filter Board to obtain specified accuracy.

ENDEVCO 6634C INSTRUCTION MANUAL

4. SET JUMPERS

Before replacing cover, set the internal jumpers as desired. Jumper locations and settings are shown on Figure 2-4. W7 sets the DC Full Scale Output to 1V, 5V, or 10V, and W5 sets the AC Full Scale Output to 1V, 5V, or 10V (refer to Section 3.3 for more information). W1 selects Velocity Coil or RCC input in Model 6634C-XSF only (refer to Section 3.2 for more information).

5. POWER UP

Replace the cover and tighten the four screws in place. Then, plug the power cord into the power receptacle on the rear of the unit and into an electrical receptacle with the appropriate voltage and frequency.

WARNING: TO PREVENT SERIOUS INJURY, ENSURE THAT THE COMMON CONNECTION OF THE POWER OUTLET IS CONNECTED TO EARTH GROUND RETURN.

There is no power switch on unit. Unit is powered-up upon plugging power cord into live receptacle. On power-up, the microprocessor runs a self-test. All LEDs are turned on for a few seconds during self-check. The serial interface address will be displayed on the front-panel digital display for a few seconds, if the optional serial interface is installed. The front-panel digital display will display an Error Message if a malfunction is detected. Front-panel error messages, which may occur at power-up, are:

Err#	Description	Acknowledge by
Err2	EPROM Checksum Error	System Stop
Err3	RAM Error	System Stop
Err4	Setup RAM Checksum Error	<ENTER>
Err5	Calibration RAM Checksum Error	<ENTER>
Err6	Keyboard Error	System Stop

If an Error Message is displayed, go to Section 5 of this manual for trouble-shooting instructions. A steady numerical display on the front-panel display indicator indicates that the Model 6634C is functioning correctly.

6. CHECKING OUT UNIT

How to check out the Model 6634C, using the front panel keyboard.

A. INTERCONNECT SYSTEM

With the power turned OFF, connect an input cable and appropriate transducer to one of the inputs on the rear panel of the Model 6634C. It is not necessary to connect output cabling at this time.

Turn on the power. The 6634C always powers up in "LOCAL" mode, in which the operating commands are taken from the front panel keyboard. With the Serial Interface Board installed, the unit can be commanded to change to the "REMOTE" mode by a Remote Command sent over the RS-232 bus (when the LOCAL/REMOTE pins are connected together).

**ENDEVCO 6634C
INSTRUCTION MANUAL**

B. LOCAL MODE

In the LOCAL Mode, the front panel displays the vibration amplitude of the DC Output in a fixed decimal format (decimal point fixed by the selected full scale). The OUTPUT LEDs show the selected output in Engineering Units (AC Output unit = g, ips, or mils), and the type of indication on the DC Output (RMS, average, or peak [pk-pk for displacement]). The ALARM LEDs illuminate when the DC output exceeds the Warning or the Alert Alarm levels. The digital display shows a flashing OL whenever the AC or DC Output is overloaded.

In LOCAL Mode, any of the programmed settings can be displayed by pressing the appropriate key on the front panel keypad. Pressing <ENTER> accepts the displayed setting and reverts to normal display. Alternately, the display reverts to normal mode after about 20 seconds. The following table lists the possible responses to pressing the various keys (items marked * only operate with optional filter installed, items marked ** only operate with optional serial interface installed). Pressing <ENTER> executes selection.

SINGLE KEYPRESS:

TYPE

SENS

DC OUT

MODE

FS

IN/OUT*

UPPER CUTOFF*

LOWER CUTOFF*

ALARM WARNING

ALARM ALERT

RESET

MULTIPLE KEYPRESS:

<ENTER><3>**

<ENTER><1>

<ENTER><6>

<ENTER><Reset>

UNIT RESPONDS WITH:

SEPE Single-Ended PE

DIFF Differential PE

UEL Velocity Coil

EPE RCC Input (if installed)

Digital Display shows Input Sensitivity

Flashes DC Output Type (RMS, avg, pk) LED

Flashes AC/DC Output Units (g, ips, mils) LED

Digital Display shows Full Scale Output

Digital Display shows Filter In or Out

Digital Display shows Cutoff (-3 dB) Frequency

Digital Display shows Cutoff (-3 dB) Frequency

Digital Display shows Warning Setting (% FS)

Digital Display shows Alert Setting (% FS)

Pressing RESET resets both alarm settings

UNIT RESPONDS WITH:

Digital Display shows Serial Interface Address

Store Setup to Non-volatile Memory

Recall Setup from Non-volatile Memory

Lock/Unlock Keyboard

By checking the programmed settings, the current state of the unit (stored in Non-Volatile Memory) is determined.

Setups can be stored and recalled from Non-Volatile Memory. Any present setup can be stored to one of 10 registers by pressing <ENTER> then <1> to activate Storage Mode. The display flashes "Str" to indicate Storage Mode. Pressing a register number (0 through 9) and <ENTER> while the "Str" is flashing stores the setup and returns unit to normal mode. (The unit automatically returns to normal mode if no key is pressed.) Similarly, any one of the 10 setups can be recalled by pressing <ENTER> then <6> to activate recall mode. The display flashes "rCL" to indicate recall mode. Pressing a register number (0 through 9) and <ENTER> while the "rCL" is flashing recalls the selected setup and returns the unit to normal mode.

The keyboard can be locked-up to prevent accidental setup changes. Pressing <ENTER> then <RESET> will lock-up the keyboard. Pressing <ENTER> then <RESET> again will unlock the keyboard. When the keyboard is locked-up, only the <ENTER> and <RESET> keys are operational, and the display shows "dbL" (disabled) for a few seconds. When the keyboard is unlocked, the display shows "EbL" (enabled) for a few seconds.

ENDEVCO 6634C INSTRUCTION MANUAL

C. REMOTE MODE

In the REMOTE mode, the front panel continuously displays the RS-232 address, Adnn, where nn is the address of the unit. In the Remote Mode, any of the settings can be programmed by sending commands over the RS-232 bus to the Model 6634C. The same checks which were made in the previous paragraphs can be performed over the RS-232 bus. This technique will be covered in Section 4 of this manual.

Connect the computer/controller to the Model 6634C via the RS-232 bus as follows. Turn off the power to both the controller and the 6634C. Attach the interconnect cable to the RS-232 connector at the computer/controller and to the RS-232 connector on the rear panel of the 6634C. Tie the LOCAL/REMOTE pins on the serial interface connector together. If more than one Model 6634C is used, connect all the RS-232 Transmit pins (on the 6634C's) to the computer/controller Receive pin. Connect all the RS-232 Receive pins (on the 6634C's) to the computer/ controller Transmit pin.

No two 6634C's can have the same RS-232 address (except \emptyset , see below). The address of each 6634C can be set from the front panel (in Local mode). Press <ENTER> then <3>. The front panel displays Adnn, where nn is the present address of the unit. Input the new desired address, from 1 to 16, and press <ENTER>. Unit returns to normal mode with new address installed. Address \emptyset disables REMOTE operation. Address \emptyset is the factory-set address for the Model 6634C.

Up to 16 Model 6634C units can be daisy-chained with a single computer/controller. All 6634C can receive commands simultaneously from controller, but only one (at a time) can be made Listener/Talker (see Section 4, Operation with RS-232 Interface).

7. CONNECTIONS

Operating conditions and input/output connections.

The ENDEVCO Model 6634C Vibration Amplifier may be located in a normal laboratory operating environment. Specified performance is obtained over the following limits:

Temperature: +41 to 122°F (+5 to 50°C)

Humidity: 0 to 95% relative humidity

A. PREPARE CONNECTIONS

The input connections to the Model 6634C are standard BNC coaxial and Endevco P/N EP316 differential connectors. The output connections from the Model 6634C are standard 25-socket, "D" connectors (Endevco P/N EJ370). Wiring diagrams for these connectors are shown in Figure 2-1 and 2-3.

B. SYSTEM CALIBRATION

Calibration is performed at ENDEVCO on each Model 6634C. For a pre-operational checkout and unit calibration, perform the following System Calibration:

For a calibration of each 6634C channel, pulse the /SYS-CAL input (TTL digital discrete input, or ground /SYS-CAL) low for at least 100 milliseconds while applying a 5.000V pk, 300.0 Hz sinewave signal at the EXT-CAL input (and at the VEL COIL/RCC input, if velocity coil or RCC input requires calibration). Allow 3 minutes for the test to be completed. As the Calibration process proceeds, the Cal Status is shown on the front panel display as follows: adjusting the dc offset (CAL1), adjusting the full scale output and the integrators (CAL2), adjusting the input sensitivities (CAL3), adjusting the filter cutoffs (CAL 4, if filter is installed). Failure of Calibration is signaled by displayed error messages.

ENDEVCO 6634C INSTRUCTION MANUAL

Continue the Calibration procedure listed above for each 6634C channel installed in the rack (/SYS-CAL can be daisy chained to calibrate all 6634C units at the same time). If all channels Calibrate without errors, the system is fully calibrated and ready to operate. The operation command instructions are described in Section 3.

If the optional programmable Filter (Model 35840A) is installed by user in the field, the unit must be recalibrated for optimum filter performance. Simply repeat the System Calibration described above.

A detailed discussion of the Calibration process is provided in Section 3.7/4.6.

For more detailed testing of the unit, such as frequency response, etc., an external electrical input can be used or the transducers can be placed on a transducer calibration system (shaker, etc.) for providing a calibrated input at any frequency of interest.

C. EXTERNAL ALARM HOOKUPS

Hookup requirements for alarms are as follows: (Reference Figure 2-1)

NOTE: The maximum sink current available from the 6634C is approximately 20mA, due to a 200 ohm series resistor.

Pin 4	Analog ground
Pin 14	/Overload
Pin 15	Alarm Alert
Pin 16	Alarm Warning
Pin 17	+5 Volts DC
Pin 19	Alarm Reset
Pin 20	Digital Ground

Setup: Pins 14, 15, and 16 are TTL outputs, normally high.

Alarm Reset: Pin 19 a TTL signal, normally high, may be momentarily shorted to ground to reset the 6634C.

**ENDEVCO 6634C
INSTRUCTION MANUAL**

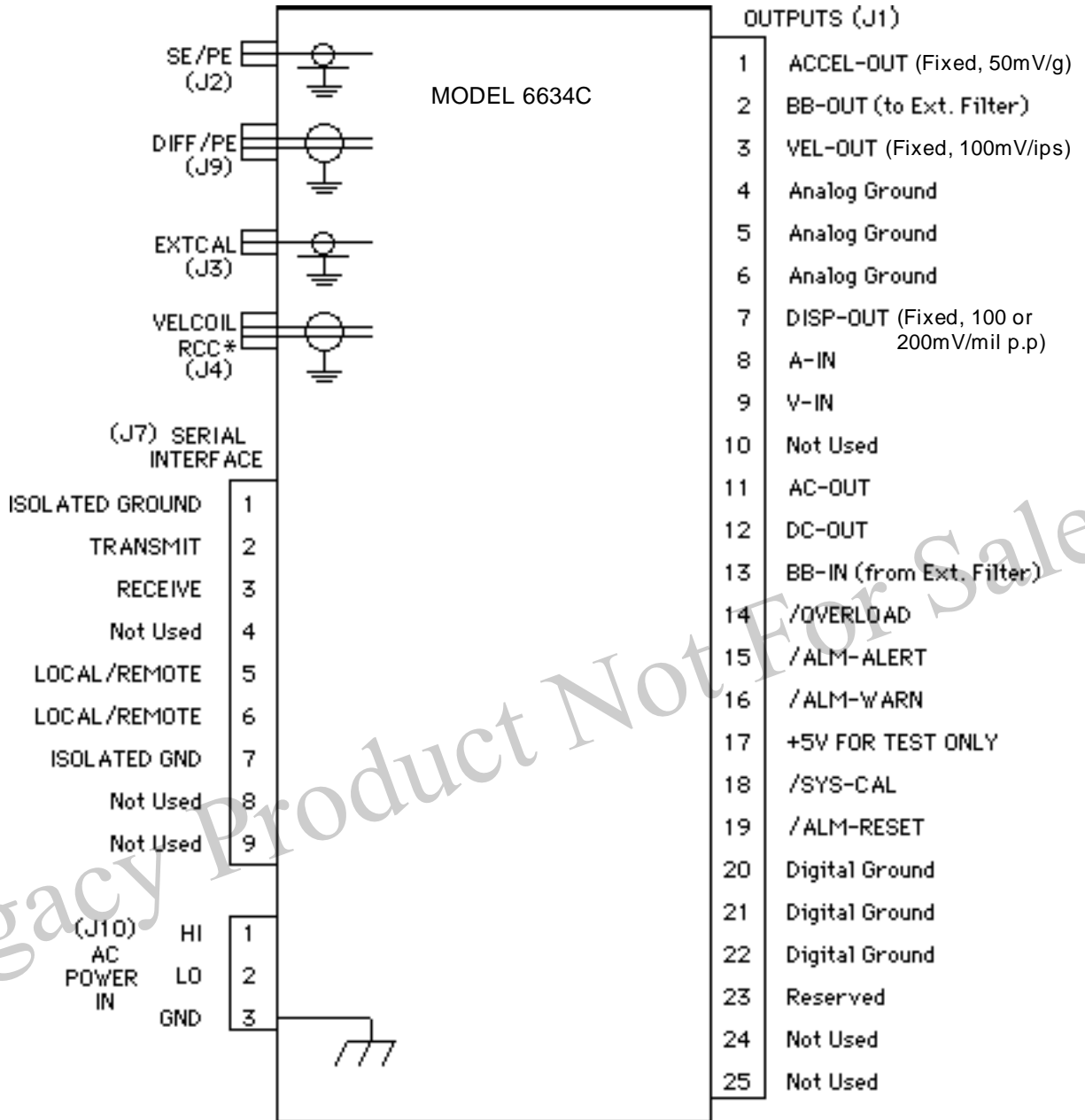

* 'pin' is grounded at 6634C end  ← Pin (Ground)
 ← Socket

Figure 2-1: Wiring diagram for input and output connectors.

**ENDEVCO 6634C
INSTRUCTION MANUAL**

C. INTERCONNECT RS-232 INTERFACE

With the rack power off, plug in the cable connecting the computer/controller RS-232 interface to the RS-232 interface connector (optional) on the rear panel of the Model 6634C enclosure. The RS-232 Connector (Endevco P/N EJ584) pin connections are shown in Figure 2-2.

Connect an input cable and transducer to the appropriate input connection on the rear panel of the Model 6634C enclosure. It is not necessary to connect output cabling at this time.

The Model 6634C is ready to accept commands via the RS-232 interface. Send the appropriate RS-232 command strings to the Model 6634C using standard RS-232 conventions. Complete information on the use of command strings is given in Section 4.

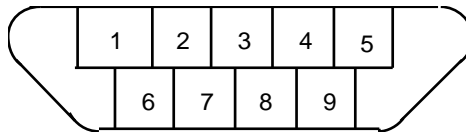

<u>PIN #</u>	<u>DESCRIPTION</u>
1	ISOGND (Isolated from 6634C ground)
2	TRANSMIT
3	RECEIVE
4	Not Used
5	LOCAL/REMOTE
6	LOCAL/REMOTE
7	ISOGND (Isolated from 6634C ground)
8	Not Used
9	Not Used

Figure 2-2: Serial Interface (RS-232) Cable Connector Pinouts

8. ACCESSORY LIST

The following accessories are supplied with, or are optional for, the Model 6634C:

<u>ITEM</u>		<u>PART NUMBER</u>	<u>QUANTITY</u>
Power Cable	95-265V	17180	1
Connector	Twin BNC	EP316	2
Connector	25-pin, "D"	EJ600	1
Adapter	BNC F to 10-32	EJ21	Opt
Manual	IM6634C	1	
Rack		4948	Opt
Programmable Filter		35840A	Opt
Serial Interface		35843	Opt

**ENDEVCO 6634C
INSTRUCTION MANUAL**

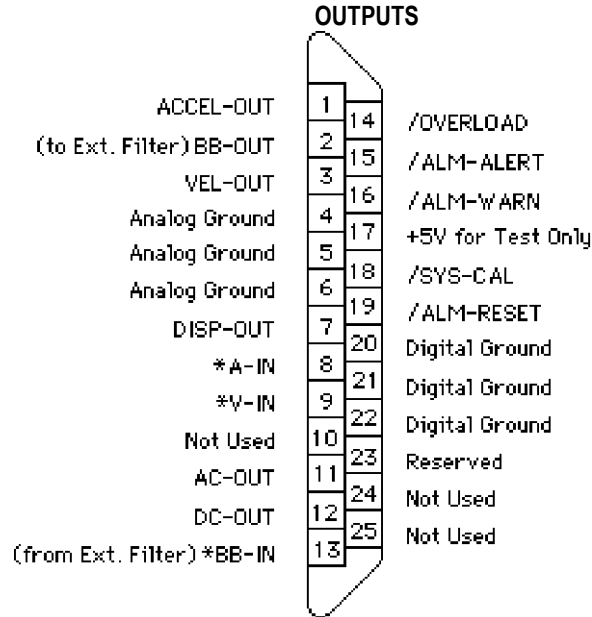

Note 1: "/" means Active Low

Note 2: "*" indicates that proper jumper should be installed to enable external Accel, Vel, and/or Broadband inputs (refer to Figure 2-4).

Figure 2-3: Input/Output Connector Pinouts

10. JUMPER CONFIGURATION

The figure 2-4 diagram shows how the W1 and W8 jumpers should be set for each type of input.

Isotron/RCC	The current source is connected to the J4 A input to supply power to a remote charge converter and couple the acceleration output to the signal conditioner. J4 B is connected to signal ground.
Differential Velocity	The J4 A and B inputs are differential voltage inputs referenced to the signal ground (shell). This configuration is normally used with a velocity coil.
Single-ended Velocity	J4 B is tied to signal ground. This configuration is used with 2 wire velocity coil inputs.
2777 Acceleration Output	This configuration supplies 24VDC to the 2777 on the J4 A input pin and couples the acceleration signal to the signal conditioner input. J4 B is tied to signal ground.
2777 Velocity Output	24VDC is supplied to the 2777 on the J4-A input pin. J4-B is tied to signal ground. The input signal DC bias voltage is blocked by using the Isotron input circuit. The gain is scaled to be the same as the velocity input. (NOTE: If 24VDC is supplied to the 2777 externally, the jumper installed in position 17, 18 of W8 should be moved to the "24V Disable" position 7, 8.)

- W2 - A jumper is installed to enable external acceleration signal inputs.
- W3 - A jumper is installed to enable external broadband signal inputs.
- W4 - A jumper is installed to enable external velocity signal inputs.
- W9 - A jumper is installed to enable DRCC or velocity input software. * Not Implemented

ENDEVCO 6634C INSTRUCTION MANUAL

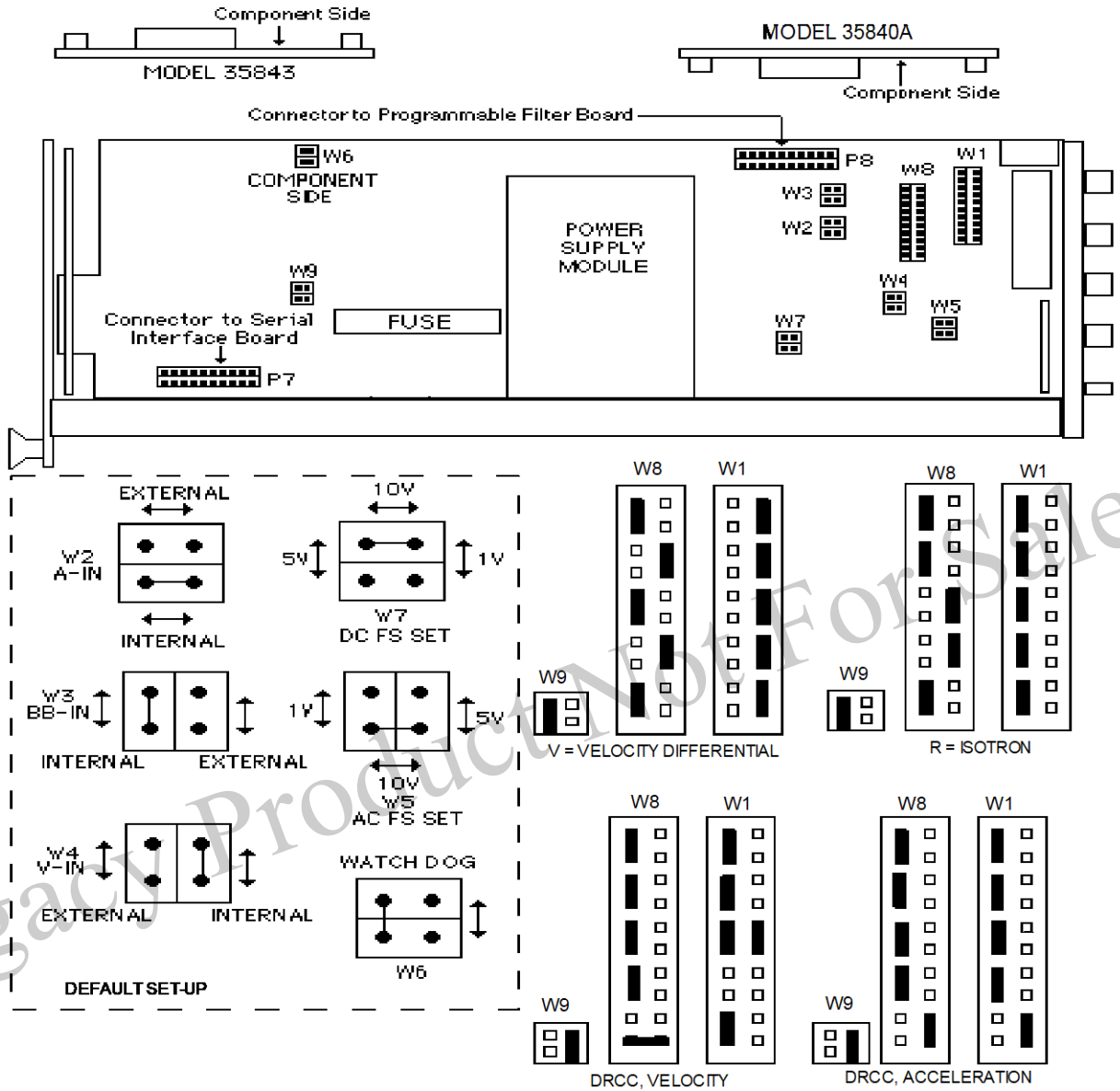

Figure 2-4: Jumper Locations on Main Board

**ENDEVCO 6634C
INSTRUCTION MANUAL**

**SECTION 3:
OPERATING INSTRUCTIONS**

1. **KEYBOARD AND DISPLAY**

The Model 6634C is controlled using the keyboard and display when operating in the default, Local Mode.

When the 6634C is powered-up, it is in the LOCAL MODE, where the unit takes its instructions from the keyboard, and the vibration level is shown on the digital display. At power-up, all LEDs are illuminated for a few seconds.

The unit can be switched to REMOTE MODE by a Remote command sent to the unit over the (optional) Serial Interface (LOCAL/REMOTE pins must also be connected together for Remote Mode operation). Remote operation is described in Section 4 of this Manual.

The front panel of the Model 6634C is divided into the display area (upper panel) and the keyboard area (lower panel). The display area is divided into three sections:

DIGITAL READOUT (four-digit, seven-segment numeric displays)

ALARM INDICATORS (two individual LEDs)

Warning and Alert

OUTPUT INDICATORS (six individual LEDs)

Three for mode of operation (g, ips, mils)

Three for DC scaling (RMS, Avg, Pk)

The keyboard is divided into five sections:

INPUT

OUTPUT

FILTER

ALARM

ENTER

2. **NORMAL MODE**

In the Normal Mode, the Digital Readout displays the vibration amplitude of the DC Output. One of the top row of the Output Indicators is illuminated indicating the selected engineering units (g, ips, mils). One of the bottom row of the Output Indicators is illuminated indicating the selected mode of AC/DC conversion (rms, average, peak [pk-pk for displacement]). The Alarm Indicators are illuminated if their respective alarm levels are exceeded (warning and alert level are individually settable). The Digital Readout flashes "OL" whenever the AC or DC Outputs are saturated.

**ENDEVCO 6634C
INSTRUCTION MANUAL**

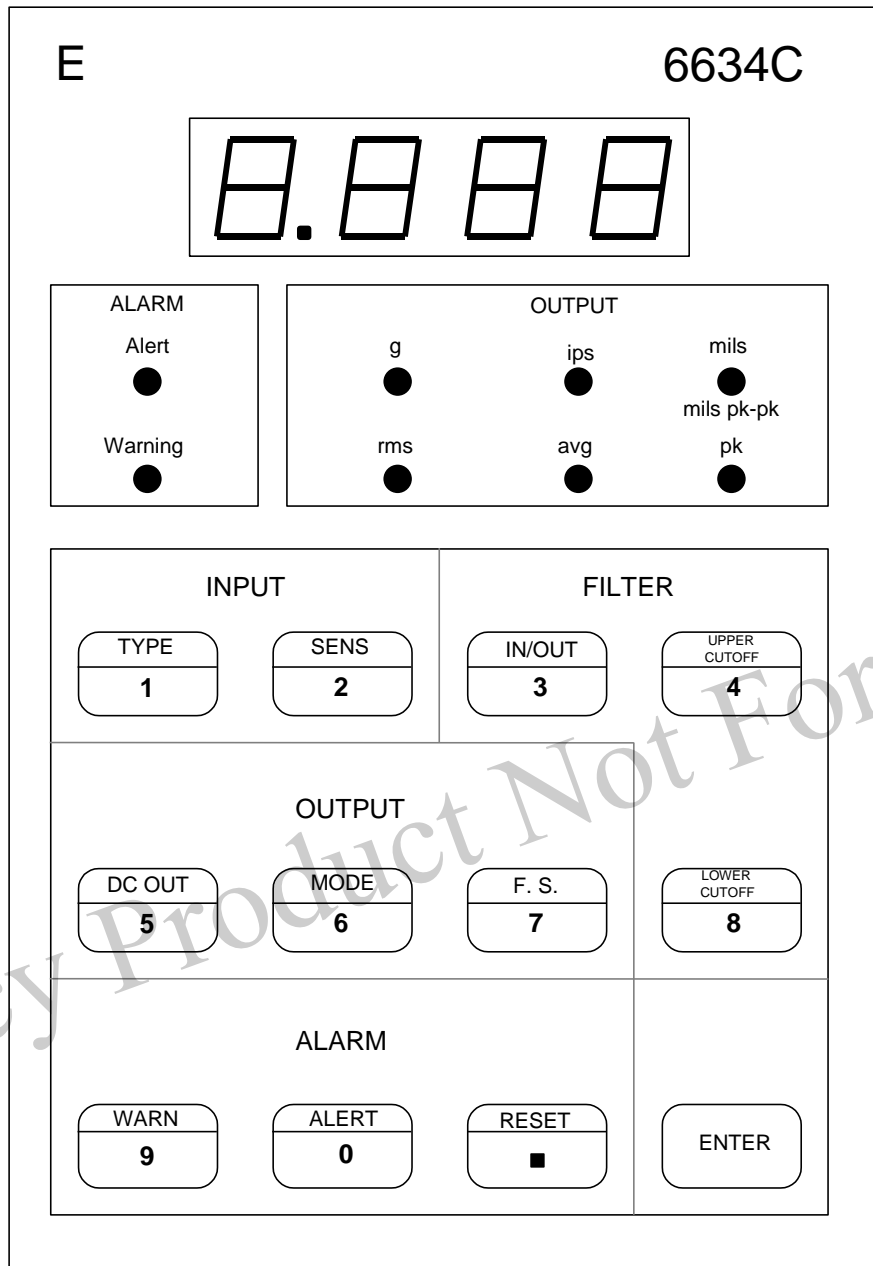

Figure 3-1: Keyboard Diagram of Model 6634C.

3. INPUT SETTINGS

The Model 6634C can be set to accept inputs from a variety of transducers and can be set to the sensitivity of the transducer so that the outputs are normalized to engineering units.

When the 6634C is powered-up, it is in the LOCAL MODE, where the unit takes its instructions from the keyboard. At power-up, the input is set to the default input type and input sensitivity which was previously stored in non-volatile memory. The Digital Readout displays the vibration amplitude corresponding to the DC Output setting with the decimal point fixed by the output full scale setting.

ENDEVCO 6634C INSTRUCTION MANUAL

A. INPUT TYPE

Pressing TYPE in the Normal Mode will cause the Digital Readout indicator to flash the present input type setting of the 6634C. The indicator will flash the following codes for each input setting:

SEPE	single-ended Piezoelectric (PE) transducer
DIFF	differential PE transducer
VEL	velocity coil, DRCC (velocity output)
IEPE	RCC input (optional) DRCC acceleration output

CAUTION: Damage may result if the PE and ISOTRON units are not isolated to prevent potential ground loops. Differential units are not affected.

While the INPUT TYPE is being indicated, the ALARM and OUTPUT displays are off.

To change the present setting, press TYPE again. The display will scroll to another input choice each time TYPE is pressed. When the desired choice is displayed, press ENTER. The new input choice is implemented, and the unit returns to Normal Mode. The unit automatically returns to Normal Mode if no key is pressed for about 20 seconds. The new input choice is stored as the default in non-volatile memory.

Switching between Velocity Coil and RCC input types is accomplished by moving internal jumpers on W1 and W8. W9 is used to enable DRCC software. Figure 2-4 shows the correct jumper setting for each type of input.

B. INPUT SENSITIVITY

Pressing SENS in the Normal Mode will cause the Digital Readout Indicator to flash the present sensitivity setting of the 6634C. The indicator will flash the sensitivity setting with the appropriate units for the selected input type, as follows:

pC/g	Single-ended or Differential PE
mV/ips	velocity coil or DRCC, VEL OUT
mV/g	RCC input or DRCC, ACC OUT

While the INPUT SENSITIVITY is being indicated, the ALARM and OUTPUT displays are off.

To change the present setting, type in the desired sensitivity using the numeric keys. The display will flash the numbers entered. If an illegal value is entered, the display flashes ERR1, indicating that an allowable value should be reentered. When the desired entry is displayed, press ENTER. The new sensitivity is implemented, and the unit returns to Normal Mode. The unit automatically returns to Normal Mode if no key is pressed for about 20 seconds. Different sensitivities can be selected for each input type. The new sensitivity settings are stored as the defaults for selected input type in non-volatile memory.

NOTE: When using the DRCC acceleration output, the sensitivity of the transducer is multiplied by the gain of the DRCC and the product is divided by 10. The sensitivity of the 6634C should be set a factor of 10 lower than the transducer sensitivity times the DRCC gain.

$$\text{SENS} = (\text{SENS} \times \text{DRCC GAIN}) / 10$$

The allowable sensitivity ranges are as follows:

PE (single-ended or differential)	1.500 to 150.0 pC/g
Velocity Coil	15.00 to 1500 mV/ips
RCC Input	1.500 to 150.0 mV/g

**ENDEVCO 6634C
INSTRUCTION MANUAL**

4. OUTPUT AND DISPLAY SETTINGS

The Model 6634C can be set to provide display and outputs in a variety of engineering units.

At power-up, the outputs are set to the default settings which were previously stored in non-volatile memory. The Digital Readout displays the vibration amplitude corresponding to the DC Output with the decimal point fixed by the output full scale setting.

A. MODE

Pressing MODE in the Normal Mode will flash the AC and DC Output engineering unit LED corresponding to the present setting ("g", "ips", or "mils") of the 6634C. While the Mode is being indicated, the ALARM and Digital Readout displays are off.

To change the present setting, press MODE again. The display will scroll to another output choice each time MODE is pressed. When the desired choice is displayed, press ENTER. The new output engineering units choice is implemented, and the unit returns to Normal Mode. The unit automatically returns to Normal Mode if no key is pressed for about 20 seconds. Different Output engineering units can be selected for each input type (PE, Velocity Coil, RCC Input). The new output choices are stored as the defaults for each input type in non-volatile memory.

B. DC OUT

Pressing DC OUT in the Normal Mode will flash the DC Output unit LED corresponding to the present setting ("RMS", "AVG", or "PK") of the 6634C. While the DC OUT is being indicated, the ALARM and Digital Readout displays are off.

To change the present setting, press DC OUT again. The display will scroll to another output choice each time DC OUT is pressed. When the desired choice is displayed, press ENTER. The new output choice is implemented, and the unit returns to Normal Mode. The unit automatically returns to Normal Mode if no key is pressed for about 20 seconds. Different DC Output units can be selected for each input type (PE, Velocity Coil, RCC Input). The new output choices are stored as the defaults for each input type in non-volatile memory.

C. FULL SCALE

Pressing F.S. in the Normal Mode will cause the Digital Readout Indicator to flash the present Full Scale setting of the 6634C. At the same time, the Output Display LED flashes the engineering unit and the DC Output unit LED flashes "pk" ("pk-pk" for displacement). While the Full Scale is being indicated, the ALARM display is off.

To change the present setting, type in the desired Full Scale using the numeric keys. The display will flash the numbers entered. If an illegal value is entered, the display flashes ERR1, indicating that a new value should be reentered. When the desired entry is displayed, press ENTER. The new Full Scale is implemented, and the unit returns to Normal Mode. The unit automatically returns to Normal Mode if no key is pressed for about 20 seconds. Different Full Scale settings can be selected for each input type and output mode. The new Full Scale settings are stored as the defaults for each input type and output mode in non-volatile memory.

The allowable Full Scale ranges are as follows:

Acceleration	2.00 to 200 g pk
Velocity	1.00 to 100 ips pk
Displacement	0.500 to 50.0 mils pk-pk

**ENDEVCO 6634C
INSTRUCTION MANUAL**

D. FULL SCALE OUTPUT VOLTAGE

The AC and the DC Full Scale Output Voltages can be independently set to 1V, 5V, and 10 V, by moving internal jumpers. The W7 jumper on the main board controls the DC Output Voltage selection, and the W5 jumper on the main board controls the AC Output Voltage selection. The locations of these two jumpers are shown in Figure 2-4. The shorting clip should be moved to the position corresponding to the desired output F.S. voltage on each jumper.

5. PROGRAMMABLE FILTER

An optional programmable filter (Model 35840A) may be used to limit the frequency range of the signal being measured and output.

The Programmable Six-Pole Filter is available in two configurations. 35840A jumper position provides a low-pass programming range of 50 Hz to 5,000 Hz or 100 Hz to 10,000 Hz (-3 dB point). (Note: The -5% frequency point can be obtained by multiplying the Cutoff Frequency by 1.2 for the high pass filter and by 0.833 for the low pass filter.)

At power-up, the filter corner frequencies are set to the default settings which were previously stored in non-volatile memory. The Digital Readout displays the vibration amplitude corresponding to the DC Output (measured on the signal amplitude in the pass band) with the decimal point fixed by the output full scale setting.

A. FILTER IN/OUT

Pressing IN/OUT in the Normal Mode will cause the Digital Readout Indicator to flash the present filter condition ("In" or "Out") of the 6634C. While the filter condition is being indicated, the ALARM and OUTPUT displays are off. If no filter is installed, the Digital Readout Indicator will flash "Err0", and the only keypress that will be accepted is ENTER.

To change the present setting, press IN/OUT again. The display will toggle between "in" and "Out" each time IN/OUT is pressed. When the desired choice is displayed, press ENTER. The new filter condition choice is implemented, and the unit returns to Normal Mode. The unit automatically returns to Normal Mode if no key is pressed for about 20 seconds. A different filter condition can be selected for each input type (PE, Velocity Coil, RCC Input) and output mode. The new filter condition choices are stored as the defaults for each input type and output mode in non-volatile memory.

NOTE: With the filter disabled, the acceleration output frequency response is from 2 Hz to 30 kHz. With the filter enabled, the acceleration output frequency response will exhibit characteristics of the filter specifications.

B. CUTOFF FREQUENCIES

Pressing UPPER CUTOFF or LOWER CUTOFF in the Normal Mode will cause the Digital Readout Indicator to flash the present corresponding (upper or lower) filter cutoff frequency of the 6634C. While the cutoff frequency is being indicated, the ALARM and OUTPUT displays are off. If no filter is installed, the Digital Readout Indicator will flash "Err0", and the only keypress that will be accepted is ENTER.

To change the present setting, type in the desired Filter Cutoff using the numeric keys. The display will flash the numbers entered. If an illegal value is entered, the display flashes ERR1, indicating that a new value should be reentered. When the desired entry is displayed, press ENTER. The new cutoff frequency is implemented, and the unit returns to Normal Mode. The unit automatically returns to Normal Mode if no key is pressed for about 20 seconds. Different cutoff frequencies can be selected for each input type/output mode combination. The new cutoff frequency settings are stored as the defaults for each input type/output mode combination in non-volatile memory.

ENDEVCO 6634C INSTRUCTION MANUAL

The High and Low Pass Filters provide 36 dB/octave rolloffs with the allowable Cutoff (-3dB) Frequency ranges as follows:

High Pass	5 to 500 Hz
Low Pass	50 to 5000 Hz, Jumper selected 100 to 10,000 Hz, Jumper selected

C. EXTERNAL FILTER

To use the 6634C in the external filter mode, install filter between pin 2, "BB-OUT", and pin 13, "BB-IN", of the 25 pin Output connector. Move jumper W3 (internal to unit) from the 1-2 position to the 3-4 position. With W3 in the 3-4 position, either an external filter must be installed, or a jumper must be installed between pins 2 and 13 of the Output connector to complete the signal path. When using an external filter you are still able to use an internal filter with the "FILTER IN/OUT" key on the front panel.

6. ALARM

Warning and Alert alarms are provided when the vibration signal exceeds preset levels. At power-up, the alarm levels are set to the default settings which were previously stored in non-volatile memory. The Digital Readout displays the vibration amplitude corresponding to the DC Output with the decimal point fixed by the output full scale setting.

A. ALARM LEVELS

Pressing WARNING or ALERT in the Normal Mode will cause the Digital Readout Indicator to flash the present corresponding ("Warning" or "Alert") Alarm Level of the 6634C. While the Alarm Level is being indicated, the ALARM and OUTPUT displays are off.

To change the present setting, type in the desired Alarm Level using the numeric keys. The Alarm Level is stated in percent of Full Scale, and the allowable levels are from 1.0% to 100.0% of Full Scale. Setting an Alarm Level of 100.0% disables the alarm.

The display will flash the numbers entered. If an illegal value is entered, the display flashes ERR1, indicating that a new value should be reentered. When the desired entry is displayed, press ENTER. The new Alarm Level is implemented, and the unit returns to Normal Mode. The unit automatically returns to Normal Mode if no key is pressed for about 20 seconds. Different Alarm Levels can be selected for each input type/output mode combination. The new Alarm Level settings are stored as the defaults for each input type/output mode combination in non-volatile memory.

B. ALARM RESET

The Warning and/or Alert Alarm indication is maintained even though the vibration signal subsequently drops below the corresponding Alarm Level. Pressing RESET in the Normal Mode will reset both alarms.

7. STORE/RECALL SETTINGS, KEYBOARD LOCKUP, AND BUS ADDRESS SET

Settings can be stored and recalled, keyboard can be locked-up, and REMOTE bus address can be set from keyboard.

ENDEVCO 6634C INSTRUCTION MANUAL

A. STORE/RECALL SETTINGS

Setups can be stored and recalled from Non-Volatile Memory. Any present setup can be stored to one of 10 registers by pressing <ENTER> then <1> to activate storage mode. The display flashes "Str" to indicate storage mode. Pressing a register number (0 through 9) and <ENTER> while the "Str" is flashing stores the setup and returns unit to normal mode. (The unit automatically returns to normal mode if no key is pressed.) Similarly, any one of the 10 setups can be recalled by pressing <ENTER> then <6> to activate recall mode. The display flashes "rCL" to indicate recall mode. Pressing a register number (0 through 9) and <ENTER> while the "rCL" is flashing recalls the selected setup and returns the unit to normal mode. ERR 1 is displayed if the register number to be recalled was not previously stored.

B. KEYBOARD LOCKUP

The keyboard can be locked-up to prevent accidental setup changes. Pressing <ENTER> then <RESET> will lock-up the keyboard. Pressing <ENTER> then <RESET> again will unlock the keyboard. When the keyboard is locked-up, only the <ENTER> and <RESET> keys are operational, and the display shows "dbL" (disabled) for a few seconds. When the keyboard is unlocked, the display shows "Ebl" (enabled) for a few seconds.

C. REMOTE BUS ADDRESS SET

If the Serial Interface Board, Model 35843 is installed, the address of each 6634C can be set from the front panel (in Local mode). Press <ENTER> then <3>. The front panel displays Adnn, where nn is the present address of the unit. (If no serial interface board is installed, the front panel displays ERRØ.) Input the new desired address, from 1 to 16, and press <ENTER>. Unit returns to normal mode with new address installed. Address Ø disables REMOTE operation.

8. EXTERNAL CALIBRATION

In External Calibration, critical parameters of the 6634C are adjusted to ensure performance within specification.

Before initiating the External Calibration of the 6634C, an external calibration source must be connected to the EXT CAL input on the rear panel of the unit. The external calibration source must be adjusted to provide a 5.000V pk, 300.0 Hz sinewave signal at the EXT-CAL input (and at the VEL COIL/RCC input, if velocity coil or RCC input requires calibration). Refer to Figures 2-3 and 2-4. Monitor the input signal level for loading effects caused by the 6634C.

NOTE: The 5.000 Vpk signal must be accurate and noise free.

To initiate the External Calibration process, pulse the /SYS-CAL input low for at least 100 milliseconds. Allow 3 minutes for the calibration to be completed.

As the Calibration process proceeds, the Cal Status is shown on the front panel display as follows: adjusting the dc offset (CAL1), adjusting the full scale output and the integrators (CAL2), adjusting the input sensitivities (CAL3), adjusting the filter cutoffs (CAL 4, if filter is installed).

If the calibration is successfully completed (accelerometer and velocity coil/RCC are adjusted to within calibration tolerances), the system returns to normal operation. If a problem is encountered, the "Err7" error message flashes on the display. This message is given only if both accelerometer and Velocity Coil/RCC inputs are outside calibration signal ranges or if full scale is out of calibration. The calibration constant of the out of range input type will not be modified.

ENDEVCO 6634C INSTRUCTION MANUAL

SECTION 4: OPERATION WITH RS-232 INTERFACE

1. OVERVIEW AND COMMAND FORMAT

With the optional Model 35843 Serial Interface Board, the Model 6634C can be controlled via the RS-232 interface bus by sending instructions that conform to the 6634C Command Syntax in accordance with the RS-232 protocol.

This Section provides information on controlling the 6634C from any computer/controller with RS-232 interface capability. This discussion assumes that the user is already familiar with RS-232 interfacing.

The optional Model 35843 Serial Interface Board must be installed to permit operation in the Remote Mode. With the 35843 board installed, the LOCAL/REMOTE pins of the 9-pin "D" connector must be connected together throughout the entire period of remote operation. In addition, a "Remote" command must be received over the RS-232 bus to initiate remote operation.

A. RS-232 INTERFACE

Data is sent and received over the RS-232 bus at 300 baud in 7-bit ASCII format, no parity, with one stop bit. A minimum three-wire configuration is used, with no handshake lines implemented. The internal RS-232 buffer is 600 bytes long, and commands longer than the buffer size may be lost.

The RS-232 interface is a 9-pin "D" connector and the internal transmitter/receiver complies with EIA RS-232C Standard, Section Two: Electrical Signal Characteristics (except that the input impedance of the receiver is higher and transmitter can be tristate to allow multidrop scheme).

Multiple Model 6634C's can share the same RS-232 bus. Connect all the RS-232 Transmit pins (on the 6634C's) to the computer/controller Receive pin. Connect all the RS-232 Receive pins (on the 6634C's) to the computer/controller Transmit pin.

The RS-232 transmitter/receiver ground is isolated from the Model 6634C system ground to reduce the ground noise.

Communication is done in fixed format of 7 bytes, defined as follows:

Byte 0:	Parameter
Byte 1 to 5:	Numeric value (in the format tables X= don't care)
Byte 6:	End of Message

NOTE: End of Message can be CR, LF, or ";".

B. REMOTE BUS ADDRESS SET

The address of each 6634C can be set from the front panel (in Local mode). Press <ENTER> then <3>. The front panel displays Adnn, where nn is the present address of the unit. Input the desired address, from 1 to 16, and press <ENTER>. Unit returns to normal mode with new address installed. Address 0 disables REMOTE operation.

**ENDEVCO 6634C
INSTRUCTION MANUAL**

C. MESSAGE PROTOCOL

Data sent across the RS-232 bus to and from the Model 6634C shall conform to the format shown in Table 4-1.

Byte 0	Byte 1 to 5	Byte 6	Description
<u>Remote/Local Command from Controller</u>			
Z	nnXXX	CR,LF, or ";"	Go to REMOTE if nn equal address of serial board (nn = Ø1 to 16). Address set by front panel keyboard.
Y	nnXXX	CR,LF, or ";"	Go to LOCAL (default) if nn equal address of serial board (nn = Ø1 to 16). Address set by front panel keyboard.
Z	*XXXX	CR,LF, or ";"	All the channels go to idle REMOTE mode.
Y	*XXXX	CR,LF, or ";"	All the channels will go to LOCAL.
I	nnXXX	CR,LF, or ";"	"nn" channel is active REMOTE channel. Only addressed channel becomes Listener/ Talker, while all others become idle.
I	*XXXX	CR,LF, or ";"	All REMOTE channels Active (Listen Only).
<u>Parameter Setup Command from Controller (accepted only by Active Remote Channels)</u>			
T	0XXXX	CR,LF, or ";"	Enter single-ended PE input type
T	1XXXX	CR,LF, or ";"	Enter velocity coil input type
T	2XXXX	CR,LF, or ";"	Enter RCC input type
T	3XXXX	CR,LF, or ";"	Enter differential PE input type
S	nnnnn	CR,LF, or ";"	Enter sensitivity as nnnnn (pC/g,mV/ips, or mV/g depending on input type selected)
M	0XXXX	CR,LF, or ";"	Enter acceleration output mode
M	1XXXX	CR,LF, or ";"	Enter velocity output mode
M	2XXXX	CR,LF, or ";"	Enter displacement output mode
D	0XXXX	CR,LF, or ";"	Enter rms as DC output mode
D	1XXXX	CR,LF, or ";"	Enter average as DC output mode
D	2XXXX	CR,LF, or ";"	Enter peak as DC output mode
O	nnnnn	CR,LF, or ";"	Enter full scale as nnnnn (g, ips, or mils depending on output mode selected)
F*	0XXXX	CR,LF, or ";"	Select filter out
F*	1XXXX	CR,LF, or ";"	Select filter in
L*	nnnnn	CR,LF, or ";"	Enter lower cutoff as nnnnn (Hz)
U*	nnnnn	CR,LF, or ";"	Enter upper cutoff as nnnnn (Hz)
W	nnnnn	CR,LF, or ";"	Enter warning alarm level (%)
A	nnnnn	CR,LF, or ";"	Enter alert alarm level (%)
R	XXXXX	CR,LF, or ";"	Reset both alarms
C	XXXXX	CR,LF, or ";"	Calibrate system
P	nXXXX	CR,LF, or ";"	Store setup n, n = 0 to 9
Q	nXXXX	CR,LF, or ";"	Recall setup n, n = 0 to 9

NOTES:

1. nnnnn is in floating point decimal format. Its 5-bytes value is equal to: 0.(byte0) (byte1)(byte2)(byte3) E (byte4).
2. 'I' command is enabled only in Remote mode of operation.
3. Commands marked with "*" apply only if Filter Option (Model 35840A) is installed.
4. Status commands are not allowed and Error Codes are not transmitted in 'Listen Only' mode of operation.
5. Any command which contains a syntax error will be responded to (if unit is not in Listen Only mode) by:

E	1XXXX	"BEL"	Syntax Error
---	-------	-------	--------------

Table 4-1: RS-232 Command Format List

**ENDEVCO 6634C
INSTRUCTION MANUAL**

2. INPUT SETTINGS

The Model 6634C can be remotely set to accept inputs from a variety of transducers and can be set to the sensitivity of the transducer so that the outputs are normalized to engineering units.

When the 6634C is powered-up, it is in the LOCAL MODE, where the unit takes its instructions from the keyboard. At power-up, the input is set to the input type and input sensitivity from the last used setup, which was previously stored in non-volatile memory. The Digital Readout displays the vibration amplitude corresponding to the DC Output setting with the decimal point fixed by the output full scale setting.

The unit can be switched to REMOTE MODE by a Remote command sent to the unit over the Serial Interface. (The optional Model 35843 Serial Interface Board must be installed to permit Remote Mode operation.) Even with the 35843 board installed, the LOCAL/REMOTE pins of the 9-pin "D" connector must be connected together throughout the entire period of remote operation. Then, a "Remote" command [ZnnXXX ;] received over the RS-232 bus will initiate remote operation. (If RS-232 interface connector is removed from 6634C, the unit immediately reverts to LOCAL mode of operation.)

A. INPUT TYPE

To remotely set the Input Type, send one of the following commands to the 6634C:

T0XXXX ;	Set input to single-ended PE input type
T1XXXX ;	Set input to velocity coil input type
T2XXXX ;	Set input to RCC input type
T3XXXX ;	Set input to differential PE input type

If new input type is successfully setup, no response will be provided by the 6634C. If a problem is encountered, and unit is in the Listener/ Talker mode, one of the following messages will be provided:

E0XXXX "BEL"	Function not installed, unit will proceed with previous settings
E1XXXX "BEL"	Setup entered is not allowed; unit will proceed with previous settings

To determine the current input type setting, send the following command to the 6634C (after selecting the specific 6634C unit as Listener/Talker using the InnXXX; command):

T?XXXX ; Request current input type

Unit responds with:

TnXXXX "ACK" where n is the number corresponding to byte 1 of the input type command, i.e.:

T0XXXX "ACK"	= Single-Ended PE
T1XXXX "ACK"	= Velocity Coil
T2XXXX "ACK"	= Remote Charge Converter (RCC)
T3XXXX "ACK"	= Differential PE

B. INPUT SENSITIVITY

To remotely set the Input Sensitivity, send the following command to the 6634C:

Snnnnn; Set input sensitivity to nnnnn, where nnnnn is in floating point decimal format. Its value is equal to 0.(byte0)(byte1)(byte2)(byte3) E (byte4).

ENDEVCO 6634C INSTRUCTION MANUAL

If new input sensitivity is successfully setup, no response will be provided by the 6634C. If a problem is encountered, and unit is in the Listener/Talker mode, the following message will be provided:

E1XXXX "BEL" Setup entered is not allowed; unit will proceed with previous settings

After the new sensitivity is successfully implemented, the unit returns to Normal Mode. Different sensitivities can be selected for each input type. The new sensitivity settings are stored as the defaults for each input type in non-volatile memory.

The allowable sensitivity ranges are as follows:

PE (single-ended or differential)	1.500 to 150.0 pC/g
Velocity Coil, or DRCC VEL out	15.00 to 1500 mV/ips
RCC Input	1.500 to 150.0 mV/g
DRCC ACC out	(SENS x DRCC GAIN)/10
DRCC VEL out	15.00 to 1500 mV/ips

To determine the current input sensitivity setting, send the following command to the 6634C:

S?XXXX ; Request current input sensitivity

Unit responds (if unit is in Listener/Talker mode) with:

Snnnnn "ACK" where nnnnn is sensitivity in floating point decimal format.

The sensitivity is indicated in the appropriate units for the selected input type, as follows:

pC/g	Single-ended or Differential PE
mV/ips	velocity coil
mV/g	RCC input (optional)

3. OUTPUT SETTINGS

The Model 6634C can be remotely set to provide outputs in a variety of engineering units.

At power-up, the outputs are set to the default settings which were previously stored in non-volatile memory.

A. MODE

To remotely set the Mode (acceleration, velocity, or displacement), send one of the following commands to the 6634C:

M0XXXX ;	Set unit to acceleration output mode
M1XXXX ;	Set unit to velocity output mode
M2XXXX ;	Set unit to displacement output mode

If new output mode is successfully setup, no response will be provided by the 6634C. If a problem is encountered, and the unit is in the Listener/Talker mode, the error message E1XXXX "BEL", setup is not allowed will be provided by the 6634C.

ENDEVCO 6634C INSTRUCTION MANUAL

To determine the current output mode setting, send the following command to the 6634C (after selecting the specific 6634C unit as Listener/Talker using the InnXXX; command):

M?XXXX ; Request current output mode

Unit responds with:

MnXXXX "ACK" where n is the number corresponding to byte 1 of the input type command, i.e.:

M0XXXX "ACK" = acceleration output mode

M1XXXX "ACK" = velocity output mode

M2XXXX "ACK" = displacement output mode

Different Output engineering units can be selected for each input type (PE, Velocity Coil, RCC Input). The new output choices are stored as the defaults for each input type in non-volatile memory.

B. DC OUT

To remotely set the DC Output units (RMS, average, or peak) send one of the following commands to the 6634C:

D0XXXX ; Set DC output mode to RMS

D1XXXX ; Set DC output mode to average

D2XXXX ; Set DC output mode to peak ("pk-pk" for displacement)

If new DC output mode is successfully setup, no response will be provided by the 6634C. If a problem is encountered, and the unit is in the Listener/Talker mode, the "setup is not allowed" error message E1XXXX "BEL", will be provided by the 6634C.

To determine the current DC output mode setting, send the following command to the 6634C (after selecting the specific 6634C unit as Listener/Talker using the InnXXX; command):

D?XXXX ; Request current DC output mode

Unit responds with:

DnXXXX "ACK" where n is the number corresponding to byte 1 of the input type command, i.e.:

D0XXXX "ACK" = RMS DC output mode

D1XXXX "ACK" = average DC output mode

D2XXXX "ACK" = peak DC output mode

("pk-pk" for displacement)

Different DC Output mode units can be selected for each input type (PE, Velocity Coil, RCC Input). The new output choices are stored as the defaults for each input type in non-volatile memory.

C. FULL SCALE

To remotely set the Full Scale output, send the following command to the 6634C:

Onnnnn ; Set full scale output to nnnnn, where nnnnn is in floating point decimal format. Its value is equal to 0.(byte0)(byte1)(byte2)(byte3) E (byte4).

ENDEVCO 6634C INSTRUCTION MANUAL

If new full-scale output is successfully setup, no response will be provided by the 6634C. If a problem is encountered, and the unit is in the Listener/Talker mode, the "setup is not allowed" error message E1XXXX "BEL", will be provided by the 6634C.

The allowable full -scale output ranges are as follows:

Acceleration	2.00 to 200.0 g pk
Velocity	1.00 to 100 ips pk
Displacement	0.500 to 50.0 mils pk-pk

To determine the current full-scale output setting, send the following command to the 6634C (after selecting the specific 6634C unit as Listener/Talker using the InnXXX; command):

O?XXXX ; Request current input sensitivity

Unit responds with:

Onnnnn "ACK" where nnnnn is full scale output in floating point decimal format.

After the new full scale output is successfully implemented, the unit returns to Normal Mode. Different full scale outputs can be selected for each input type and output mode combination. The new full scale output settings are stored as the defaults for each input type and output mode combination in non-volatile memory.

4. PROGRAMMABLE FILTER

The optional programmable filter may be remotely set to limit the frequency range of the signal being measured and output.

At power-up, the filter corner frequencies are set to the default settings which were previously stored in non-volatile memory.

A. FILTER IN/OUT

To remotely set the Filter (in the circuit or out of the circuit), send one of the following commands to the 6634C:

F0XXXX ; Select filter out
F1XXXX ; Select filter in

If new condition is successfully setup, no response will be provided by the 6634C. If a problem is encountered, and the unit is in Listener/Talker mode, one of the two error messages (E0XXXXBEL, filter not installed or E1XXXXBEL, setup is not allowed) will be provided by the 6634C.

To determine the current filter status, send the following command to the 6634C (after selecting the specific 6634C unit as Listener/Talker using the InnXXX; command):

F?XXXX ; Request current filter condition

Unit responds with:

FnXXXX "ACK" where n is the number corresponding to byte 1 of the filter command, i.e.:

F0XXXX "ACK" = filter out
F1XXXX "ACK" = filter in

ENDEVCO 6634C INSTRUCTION MANUAL

Different filter conditions can be selected for each input type (PE, Velocity Coil, RCC Input) and output mode. The new filter condition choices are stored as the defaults for each input type and output mode in non-volatile memory.

B. CUTOFF FREQUENCIES

To remotely set a Cutoff Frequency (-3 dB point), send one of the following commands to the 6634C:

Lnnnnn ; Set lower cutoff to nnnnn, where nnnnn is Hz in floating point decimal format. Its value is equal to 0.(byte0)(byte1)(byte2)(byte3) E (byte4).

Unnnnn ; Set upper cutoff to nnnnn, where nnnnn is Hz in floating point decimal format. Its value is equal to 0.(byte0)(byte1)(byte2)(byte3) E (byte4).

If new filter cutoff frequency is successfully setup, no response will be provided by the 6634C. If a problem is encountered, and the unit is in Listener/Talker mode, one of the two error messages (E0XXXX "BEL", filter not installed or E1XXXX "BEL", setup is not allowed) will be provided by the 6634C.

The High and Low Pass Filters provide 36 dB/octave rolloffs with the allowable Cutoff (-3dB) Frequency ranges as follows:

Lower Cutoff (High Pass) 5 to 500 Hz

Upper Cutoff (Low Pass) 50 to 5000 Hz, Jumper selected
100 to 10,000 Hz, Jumper selected

NOTE: The -5% frequency point can be obtained by multiplying the Cutoff Frequency by 1.2 for the high pass filter and by 0.833 for the low pass filter.

To determine the current filter cutoff settings, send the following commands to the 6634C (after selecting the specific 6634C unit as Listener/Talker using the InnXXX; command):

L?XXXX ; Request current lower cutoff frequency for high pass filter

U?XXXX ; Request current upper cutoff frequency for low pass filter

Unit responds with:

Lnnnnn "ACK" where nnnnn is lower cutoff frequency in floating point decimal format.

Unnnnn "ACK" where nnnnn is upper cutoff frequency in floating point decimal format.

After the new filter cutoff frequency(ies) are successfully implemented, the unit returns to Normal Mode. (If filter cutoff frequency(ies) cannot be implemented, unit provides "Err" message if in Listener/Talker mode and then returns to normal mode.) Different filter cutoff frequencies can be selected for each input type and output mode. The new filter cutoff frequency settings are stored as the defaults for each input type and output mode in non-volatile memory.

ENDEVCO 6634C INSTRUCTION MANUAL

C. EXTERNAL FILTER

To use the 6634C in the external filter mode, install filter between pin 2, "BB-OUT", and pin 13, "BB-IN", of the 25 pin Output connector. Move jumper W3 (internal to unit) from the 1-2 position to the 3-4 position. With W3 in the 3-4 position, either an external filter must be installed, or a jumper must be installed between pins 2 and 13 of the Output connector to complete the signal path. When using an external filter you are still able to use an internal filter with the "FILTER IN/OUT" key on the front panel.

5. ALARM

Warning and Alert alarms are remotely programmed and provide RS-232 signals when the vibration signal exceeds preset levels.

At power-up, the alarm levels are set to the default settings which were previously stored in non-volatile memory.

A. ALARM LEVELS

To remotely set the warning and alert Alarm Levels, send the following commands to the 6634C:

Wnnnnn; Set Warning Alarm Level, where nnnnn is % of Full Scale in floating point decimal format. Its value is equal to 0.(byte0)(byte1)(byte2)(byte3) E (byte4).

Annnnn; Set Alert Alarm Level, to nnnnn, where nnnnn is % of Full Scale in floating point decimal format. Its value is equal to 0.(byte0)(byte1)(byte2)(byte3) E (byte4).

If new Alarm Levels are successfully setup, no response will be provided by the 6634C. If a problem is encountered, and the unit is in Listener/Talker mode, the error message E1XXXX "BEL", setup is not allowed, will be provided by the 6634C.

The Alarm Level is stated in percent of Full Scale, and the allowable levels are from 1.0% to 100.0% of Full Scale. Setting an Alarm Level of 100.0% disables the alarm.

To determine the current Alarm Level settings, send the following commands to the 6634C (after selecting the specific 6634C unit as Listener/Talker using the InnXXX; command):

W?XXXX ; Request current Warning Alarm Level

A?XXXX ; Request current Alert Alarm Level

Unit responds with:

Wnnnnn "ACK" where nnnnn is Warning Alarm Level in floating point decimal format.

Annnnn "ACK" where nnnnn is Alert Alarm Level in floating point decimal format.

After the new Alarm Levels are successfully implemented, the unit returns to Normal Mode. (If Alarm Levels cannot be implemented, unit provides "Err" message if in Listener/Talker mode and then returns to normal mode.) Different Alarm Levels can be selected for each input type/output units combination. The new Alarm Level settings are stored as the defaults for each input type/output units combination in non-volatile memory.

ENDEVCO 6634C INSTRUCTION MANUAL

B. RS-232 ALARM

When the vibration levels exceed either Alarm Level, the 6634C sends the following signals on the RS-232 bus (if unit is in Listener/Talker mode):

K0XXXX "BEL" Warning alarm just triggered.

K1XXXX "BEL" Alert alarm just triggered.

To determine if either of the alarms have been triggered, send the following command to the 6634C (after selecting the specific 6634C unit as Listener/Talker using the InnXXX; command):

K?XXXX ; Request current Alarm Status

Unit responds with:

K0XXXX "BEL" Warning alarm has been triggered.

K1XXXX "BEL" Alert alarm has been triggered.

These Warning and/or Alert Alarm responses are given even though the vibration signal has subsequently dropped below the corresponding Alarm Level.

C. ALARM RESET

Because the Warning and/or Alert Alarm indication is maintained even though the vibration signal subsequently drops below the corresponding Alarm Level, the Alarms must be Reset to provide valid current indications.

To remotely Reset the Alarms, send the following command to the 6634C:

RXXXXX ; Reset both alarms

6. EXTERNAL CALIBRATION

In External Calibration, critical parameters of the 6634C are adjusted to ensure performance within specification.

Before remotely initiating the External Calibration of the 6634C, an external calibration source must be connected to the EXT CAL input on the rear panel of the unit. The external calibration source must be adjusted to provide a 5.000V pk, 300.0 Hz sinewave signal at the EXT-CAL input (and at the VEL COIL/RCC input if velocity coil or RCC calibration is required).

To initiate the External Calibration process, send the following command to the 6634C:

CXXXXX ; Calibrate system

Allow 3 minutes for the calibration to be completed.

If the calibration is successfully completed, the following response is provided by the 6634C (if the unit is in Listener/Talker mode):

CXXXXX "BEL" Calibration successfully completed

ENDEVCO 6634C INSTRUCTION MANUAL

If a problem is encountered, the most probable error message is:

E7XXXX "BEL" Calibration signal out-of-range, unit will revert to last calibration status

For more detailed testing of the unit, such as frequency response, etc., an external electrical input can be used or the transducers can be placed on a transducer calibration system (shaker, etc.) for providing a calibrated input at any frequency of interest.

7. STORE AND RECALL SETUPS

Up to 10 separate setups can be stored and recalled by command over the RS-232 bus.

A. STORE AND RECALL SETUP

The 6634C permits storing up to 10 setups in non-volatile memory for rapid and accurate test preparation. To store the current setup for later recall, send the following command over the RS-232 bus:

PnXXXX ; Store setup n, where n = 0 to 9

To recall a stored setup and implement that setup in the 6634C, send the following command over the RS-232 bus:

QnXXXX ; Recall setup n, where n = 0 to 9

If an attempt is made to recall a setup, which was not previously stored, the following response is sent from the 6634C (if unit is set to Listener/ Talker mode):

E1XXXX "BEL" Setup not previously stored

8. STATUS

Status is sent to the controller in response to specified status requests.

A. SETUP STATUS

As described in Section 4.2 through 4.5, the setup status of the 6634C can be determined by replacing Byte 1 in a command with a question mark. For example, to determine the Input Type setting of the unit, send [T?XXXX ;] and the unit will respond with the question mark replaced by the appropriate Input Type number and the semicolon replaced by "ACK". For example:

Query:

T?XXXX ;

Produces response:

T1XXXX "ACK" when unit setup for velocity coil input

B. ALARM STATUS

The alarm status of the 6634C can be determined by sending the following query (after selecting the specific 6634C unit as Listener/Talker using the InnXXX; command):

**ENDEVCO 6634C
INSTRUCTION MANUAL**

K?XXXX ; Request current Alarm Status

Unit responds with:

K0XXXX "BEL" Warning alarm has been triggered.

K1XXXX "BEL" Alert alarm has been triggered

C. ERROR STATUS

The error status of the 6634C, during power-up, can be determined by sending the following query (after selecting the specific 6634C unit as Listener/Talker using the InnXXX; command):

E?XXXX ; Request current error status

Unit may respond with any of the following error messages:

E2XXXX "BEL" ROM Checksum Error

E3XXXX "BEL" RAM Error

E4XXXX "BEL" Setup RAM Checksum Error, unit has proceeded with default setup parameters.

E5XXXXBEL Calibration RAM Checksum Error, unit has proceeded with no calibration.

D. DATA REQUEST

The 6634C can be requested to output the current vibration level data over the RS-232 bus. The vibration data can be requested by sending the following query (after selecting the specific 6634C unit as Listener/Talker using the InnXXX; command):

V?XXXX ; Request current vibration data

Unit may respond with either of the following messages:

EOLXXX "ACK" Signal is overloading

Vnnnnn "ACK" Vibration level is nnnnn, where nnnnn is vibration output (g, ips, or mils)(rms, avg, or pk (pk-pk for mils)) in floating point decimal format. Its value is equal to 0.(byte0)(byte1)(byte2)(byte3) E (byte4).

E. CHANNEL ADDRESS

The current active Listener/Talker channel address can be determined by sending the following query;

I?XXXX Request active channel address

Unit responds with:

InnXXX "ACK" Where nn is the active address

**ENDEVCO 6634C
INSTRUCTION MANUAL**

9. ASCII CHARACTER SET TABLE

ASCII CHAR	EQUIVALENT FORMS			ASCII CHAR	EQUIVALENT FORMS			ASCII EQUIVALENT FORMS			OCT	DEC	HEX	
	BINARY	OCT	DEC		HEX	BINARY	OCT	DEC	HEX	CHAR				BINARY
NUL	00000000	000	0	00	+	00101011	053	43	2B	V	01010110	126	86	56
SOH	00000001	001	1	01	,	00101100	054	44	2C	W	01010111	127	87	57
STX	00000010	002	2	02	-	00101101	055	45	2D	X	01011000	130	88	58
ETX	00000011	003	3	03	.	00101110	056	46	2E	Y	01011001	131	89	59
EOT	00000100	004	4	04	/	00101111	057	47	2F	Z	01011010	132	90	5A
ENQ	00000101	005	5	05	0	00110000	060	48	30	[01011011	133	91	5B
ACK	00000110	006	6	06	1	00110001	061	49	31	\	01011100	134	92	5C
BEL	00000111	007	7	07	2	00110010	062	50	32]	01011101	135	93	5D
BS	00001000	010	8	08	3	00110011	063	51	33	^	01011110	136	94	5E
HT	00001001	011	9	09	4	00110100	064	52	34	_	01011111	137	95	5F
LF	00001010	012	10	0A	5	00110101	065	53	35	`	01100000	140	96	60
VT	00001011	013	11	0B	6	00110110	066	54	36	a	01100001	141	97	61
FF	00001100	014	12	0C	7	00110111	067	55	37	b	01100010	142	98	62
CR	00001101	015	13	0D	8	00111000	070	56	38	c	01100011	143	99	63
SO	00001110	016	14	0E	9	00111001	071	57	39	d	01100100	144	100	64
SI	00001111	017	15	0F	:	00111010	072	58	3A	e	01100101	145	101	65
DLE	00010000	020	16	10	;	00111011	073	59	3B	f	01100110	146	102	66
DC1	00010001	021	17	11	<	00111100	074	60	3C	g	01100111	147	103	67
DC2	00010010	022	18	12	=	00111101	075	61	3D	h	01101000	150	104	68
DC3	00010011	023	19	13	>	00111110	076	62	3E	i	01101001	151	105	69
DC4	00010100	024	20	14	?	00111111	077	63	3F	j	01101010	152	106	6A
NAK	00010101	025	21	15	@	01000000	100	64	40	k	01101011	153	107	6B
SYN	00010110	026	22	16	A	01000001	101	65	41	l	01101100	154	108	6C
ETB	00010111	027	23	17	B	01000010	102	66	42	m	01101101	155	109	6D
CAN	00011000	030	24	18	C	01000011	103	67	43	n	01101110	156	110	6E
EM	00011001	031	25	19	D	01000100	104	68	44	o	01101111	157	111	6F
SUB	00011010	032	26	1A	E	01000101	105	69	45	p	01110000	160	112	70
ESC	00011011	033	27	1B	F	01000110	106	70	46	q	01110001	161	113	71
FS	00011100	034	28	1C	G	01000111	107	71	47	r	01110010	162	114	72
GS	00011101	035	29	1D	H	01001000	110	72	48	s	01110011	163	115	73
RS	00011110	036	30	1E	I	01001001	111	73	49	t	01110100	164	116	74
US	00011111	037	31	1F	J	01001010	112	74	4A	u	01110101	165	117	75
Space	00100000	040	32	20	K	01001011	113	75	4B	v	01110110	166	118	76
!	00100001	041	33	21	L	01001100	114	76	4C	w	01110111	167	119	77
"	00100010	042	34	22	M	01001101	115	77	4D	x	01111000	170	120	78
#	00100011	043	35	23	N	01001110	116	78	4E	y	01111001	171	121	79
\$	00100100	044	36	24	O	01001111	117	79	4F	z	01111010	172	122	7A
%	00100101	045	37	25	P	01010000	120	80	50	{	01111011	173	123	7B
&	00100110	046	38	26	Q	01010001	121	81	51		01111100	174	124	7C
'	00100111	047	39	27	R	01010010	122	82	52	}	01111101	175	125	7D
(00101000	050	40	28	S	01010011	123	83	53	~	01111110	176	126	7E
)	00101001	051	41	29	T	01010100	124	84	54	DEL	01111111	177	127	7F
*	00101010	052	42	2A	U	01010101	125	85	55					

ENDEVCO 6634C INSTRUCTION MANUAL

SECTION 5: MAINTENANCE

1. ROUTINE MAINTENANCE AND HANDLING

The ENDEVCO Model 6634C is a rugged, self-contained piece of electronic equipment which requires minimal maintenance and permits rapid replacement of modular assemblies.

The ENDEVCO 6634C Vibration Amplifier is designed to require no component-level repair by the user. However, detailed schematics are available upon request. When requesting schematics, specify: SC29214, SC29216, and SC29218.

The only periodic functions performed by the user, except for quality calibration considerations, are to check the integrity of any external wires and connectors in use. Any component failures simply require that the faulty subassembly be removed by the user and returned to ENDEVCO, to be replaced with a fully functional item.

WARNING: REMOVE POWER BEFORE OPENING UNIT.

Some suggestions for simple routine maintenance operations are:

A. REPLACING FUSES

Make certain that the correct fuse is installed for the power voltage selected. The Model 6634C has a 2 amp fuse. Fuse holder is located to the left of the power supply on the main board. (See Figure 5-1) If a fuse is blown, take steps to determine the cause. In particular, make certain that the line power in use matches the voltage marked on the switch. The use of improper voltages and fuse ratings can seriously damage the electronic components and void the warranty of the system.

B. IN CASE OF ACCIDENTS

If any accidental damage to the equipment occurs, such as dropping the rack, spilling liquids on the case, etc., take the following steps:

During Operation: Power down, suspends the test and visually examines the equipment. If no damage is noticed, power-up and repeat calibration as described in Section 2. If damage is observed or calibration indicates functional problems, refer to Section 5.2.

Non-Operational: Visually examine the equipment, removing and reinserting the cards if necessary. If no damage is noted, repeat power-up and calibration as described above.

2. VERIFYING AND EXCHANGING FAULTY ASSEMBLIES

Procedures for returning nonworking assemblies to ENDEVCO.

The ENDEVCO Model 6634C is manufactured to be a rugged, dependable electronic instrument. Occasionally, however, electronic boards, power supplies, etc., develop problems that make replacement necessary. The error messages previously described indicate when certain hardware problems have occurred and will assist in locating the problem. The 6634C Vibration Amplifier is comprised of plug-in cards to enable the user to quickly and easily replace faulty cards when they are shown to be defective.

If an error message indicates a failure, first check all cables and connections for breaks and proper seating. If necessary, replace cables with others that are known to be reliable. Next, switch the malfunctioning card with one that is known to be functioning correctly to see if the trouble persists. In this manner the fault can be traced to a plug-in

ENDEVCO 6634C INSTRUCTION MANUAL

card. There are no user serviceable assemblies in the 6634C Vibration Amplifier. If a card is determined to be faulty, return it to ENDEVCO following the policy stated below.

A. FACTORY SERVICE

ENDEVCO maintains factory service for repair of all ENDEVCO instruments. To obtain repair or replacement of a defective instrument, return the instrument to the factory at the following address:

Endevco
www.endevco.com
Tel: +1 (866) ENDEVCO [+1 (866) 363-3826]

To return an instrument, please:

- 1- Ensure proper packaging, preferably in the original shipping cartons.
- 2- Prepay shipping and insurance charges.

B. WARRANTY RETURNS

ENDEVCO warrants each new electronic instrument to be free from defects in material and workmanship. Please refer to the appropriate Warranty Policies for terms and warranty period. Instruments returned under warranty will be repaired or replaced at no charge if the failure is due to defective material or workmanship and the unit is returned within the time period and conditions of ENDEVCO's warranty policy.

C. OUT-OF-WARRANTY-RETURNS

Enclose a purchase order not to exceed \$300 authorizing repair/calibration along with a full explanation of the failure or symptoms observed to help in fixing the problem. A copy of a Report of Failure Checklist is attached immediately following this section to assist in describing the failure that occurred. The instrument will be repaired/calibrated, returned and invoiced for the actual repair charges. If the instrument cannot be repaired for \$300 or less, ENDEVCO will submit a written quotation for the cost of the repair and/or replacement of the unit.

3. REPLACING EPROMS

Firmware upgrades are implemented by installing a new EPROM on the main circuit board.

To replace the 27256 EPROM (U38 on the Main Board), remove power by unplugging power cord from rear of unit, and remove cover by removing 4 head-head screws in top surface of unit.

WARNING: HANDLE UNCOVERED UNIT ONLY AFTER GROUNDING YOUR BODY WITH AN ESD DEVICE, SUCH AS A GROUNDED WRIST STRAP.

Locate the 27256 (U38) EPROM as shown in Figure 5-1. Using a DIP IC removal tool, pull U38 from its socket and store it in anti-static wrapping. Check the pin alignment on the replacement IC. Straighten pins if necessary. Orient the EPROM as shown in Figure 5-1. Install the IC by carefully lining up the pins with the socket holes and pressing the IC into the socket.

Replace the cover and tighten the four screws through the top surface of the cover into the unit.

**ENDEVCO 6634C
INSTRUCTION MANUAL**

A. POWER-UP

After replacing the EPROM, follow the Power-Up procedure in Section 2.

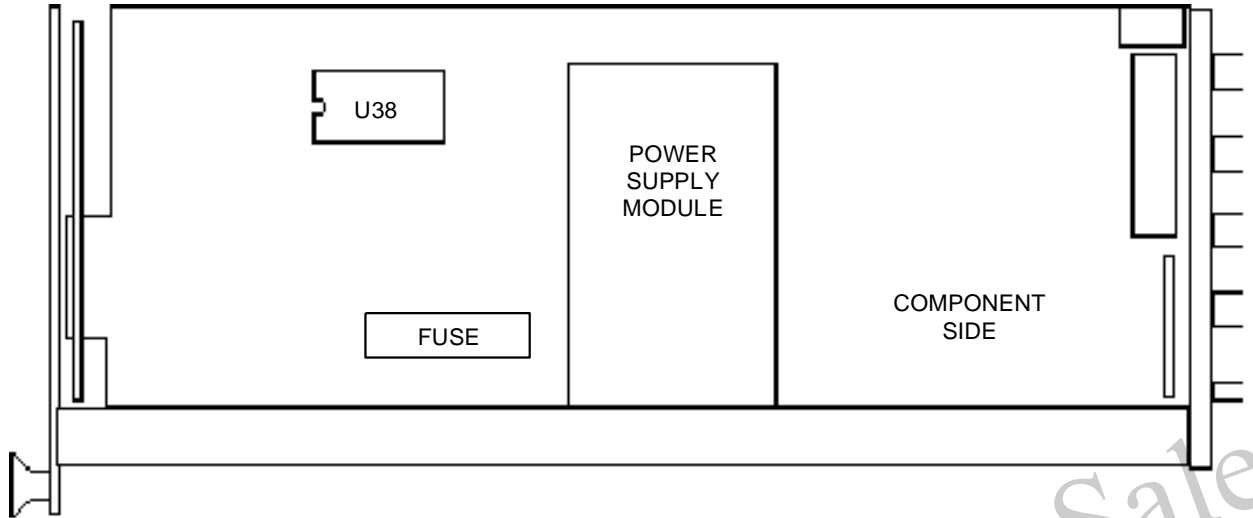

Figure 5-1: EPROM Location on Main Board.

**ENDEVCO 6634C
INSTRUCTION MANUAL**

**APPENDIX A:
DETAILED THEORY OF OPERATION**

1. **AMPLIFICATION**

The ENDEVCO Model 6634C is a single-channel amplifier which provides a wide range of modes and gains.

The ENDEVCO Model 6634C Vibration Amplifier is a programmable amplifier system composed of an Input Amplification Section, a Sensitivity Amplifier, a Filter Section (treated in Section A.3), and an Output Amplification (and integration) Section.

A. **INPUT AMPLIFICATION**

Input signals can be directed through a Charge Amplifier section or an Instrumentation Amplifier. (With the RCC option, either the Instrumentation Amplifier or the RCC amplifier can be enabled by an internal jumper. The RCC amplifier is discussed in Section A.2.)

The Charge Amplifier Section is used for single-ended or differential piezoelectric sensors, and can also be driven by an AC voltage source (up to 10 V pk) into the Ext Cal input through an internal 1000 pF ($\pm 0.5\%$) coupling capacitor. The maximum charge input must be limited to 33,000 pC pk and must be driven from a source resistance of 10 Megohms, minimum. The 6634C can handle sensor sensitivities of 1.500 to 150.0 pC/g. The Charge Amplifier operates at a fixed gain of 0.3030 mV/pC.

The Instrumentation Amplifier is used for velocity coil sensors and other voltage sources, and can be driven directly by an external voltage source for calibration. The input connection is differential and provides 100 kilohms input impedance. The 6634C can handle sensor sensitivities of 15.00 to 1500.0 mV/ips. The Instrumentation Amplifier operates at a fixed gain of 0.0606 mV/mV.

B. **SENSITIVITY AMPLIFIER**

The Sensitivity Amplifier input is programmable switched between the Charge Amplifier output and the Instrumentation Amplifier output. The Sensitivity Amplifier gain can be programmable adjusted from 1.1 to 110 in steps of 0.1%. The output of the sensitivity amplifier is available at the BB-OUT connector pin. It is also routed to the optional programmable filter or directly to the following integrator stages.

C. **INTEGRATORS**

The output of the Sensitivity Amplifier (or optional Filter) is routed to the Integrator stages and is available at the ACCEL-OUT connector pin. The first (Velocity) integrator provides a 6 dB/octave transfer function rolloff, with unity gain at 122.8 Hz. The output of the velocity integrator is available at the VEL-OUT connector pin, and is routed to the input of the second (Displacement) integrator. The displacement integrator provides a 6 dB/octave transfer function rolloff, with unity gain at 636.6 Hz. The output of the displacement integrator is available at the DISP-OUT connector pin.

The ACCEL-OUT, VEL-OUT, and DISP-OUT signals are normalized to fixed sensitivities; the Acceleration Output is 50 mV/g pk, the Velocity Output is 100 mV/ips pk, and the Displacement Output is 200 mV/mil pk-pk.

D. **RANGE AMPLIFIER**

The Range Amplifier input is programmable switched between the signals at the ACCEL-OUT, VEL-OUT, or DISP-OUT connector pins. The Range Amplifier gain can be programmable adjusted from 1 to 100 in steps of 0.1%. The output of the Range Amplifier is buffered in a gain of 0.1 and provided at the AC-OUT connector pin. The output amplifier gain can be selected to 0.5 or 1.0 by using the W5 internal jumper. See Figure 2-4 for jumper locations.

ENDEVCO 6634C INSTRUCTION MANUAL

The Range Amplifier output is also routed to the RMS-DC Converter. The RMS-DC converter's output is provided to the Analog to Digital (A/D) converter which converts the DC signal to 10-bit digital data for processing by the microcontroller.

The microcontroller performs all of the Alarm functions as well as providing digital data to the Digital to Analog (D/A) converter. The analog DC output is buffered in a gain of 0.1 amplifier and provided at the DC-OUT connector pin. The output amplifier gain can be selected to 0.5 or 1.0 using the W7 by internal jumper. See Figure 2-4 for jumper locations.

2. RCC/ISOTRON OPERATION

The optional RCC input of the ENDEVCO Model 6634C provides power to and amplifies the output from a remote charge converter or a transducer with integral electronics.

A Remote Charge Converter (RCC) is a remote electronic package which amplifies the output of Piezoelectric Accelerometers and converts from a charge signal at high impedance to a voltage signal at low impedance. ISOTRON® accelerometers contain integral electronics which generate an output voltage at low impedance. ISOTRON accelerometers are powered from the input connector of the 6634C. Calibration of the ISOTRON accelerometer is provided in mV/g, and is independent of cable length.

A. SENSOR OUTPUT SWING

Each 6634C input channel contains a constant current supply (see Figure A-2) for an RCC or ISOTRON transducer. This supply is set up to deliver 8.6mA, $\pm 10\%$ to the RCC or ISOTRON, from a voltage source of 22 ± 2 Volts (the compliance voltage). The AC data signal from the remote device travels along the same wire carrying DC power to the device. A typical ISOTRON operates at a bias voltage of $+10 \pm 1.5$ VDC, and the output can swing from zero volts to the compliance voltage. The AC output voltage is coupled through a capacitor in the input section of the 6634C to remove the DC bias voltage.

B. HIGH FREQUENCY RESPONSE

High frequency response limits must also be considered when using long cable to couple an RCC or ISOTRON to the 6634C. The current that is available to drive a cable, the peak signal level, and the cable capacitance are all important and interrelated factors that determine frequency response of the coupling system.

Assume that 2 mA of the 8.6 mA of supplied current are required for the operation of the ISOTRON. Therefore, the remaining 6.6 mA are available to drive the capacitance load of the cable. At low frequencies, the input voltage swing can reach about 10 Volts, peak. With a 300 foot long cable (300×32 pF/ft = 9600 pF), the frequency at which the voltage swing will begin to decrease is given by:

$$f_{\max} = \frac{I}{(2 \pi V C)} \quad (\text{or use Nomograph, Figure A-3})$$

where: I = available drive current, in Amperes
 V = peak sine wave signal, in Volts, and
 C = cable capacitance, in Farads

Then,

$$f_{\max} = \frac{0.0066}{(2 \pi) (10) (9600 \times 10^{-12})} = 10,942 \text{ Hz}$$

**ENDEVCO 6634C
INSTRUCTION MANUAL**

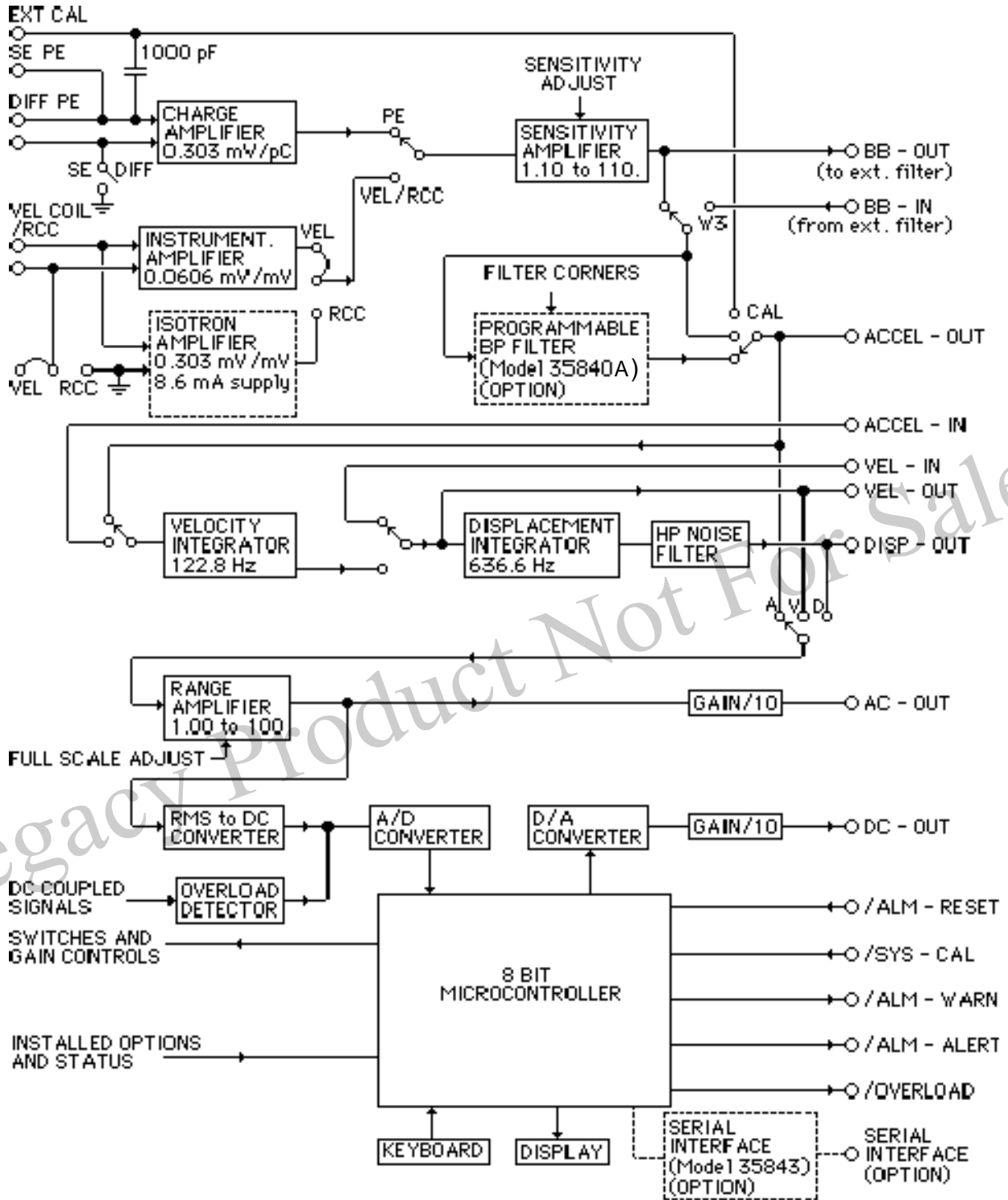

Figure A-1: Simplified block diagram of the amplification scheme of the Model 6634C.
NOTE: See Figure 2-1 for connector and pin designations

**ENDEVCO 6634C
INSTRUCTION MANUAL**

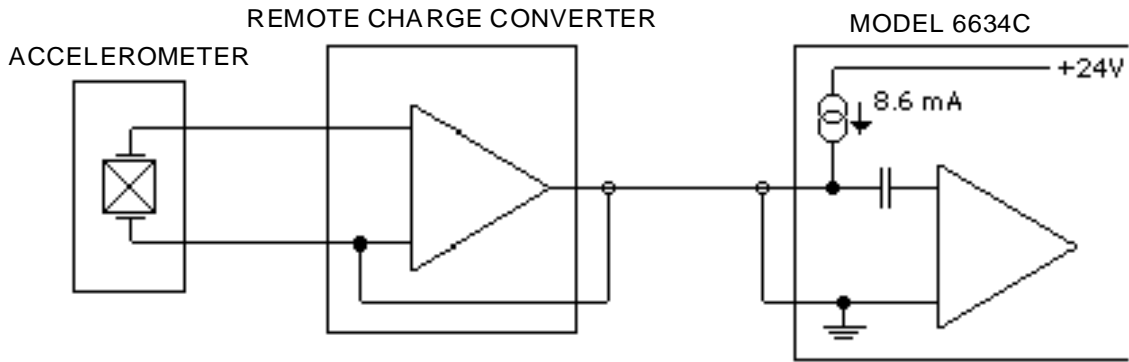

Figure A-2: Simplified Schematic of RCC/ISOTRON Circuitry.

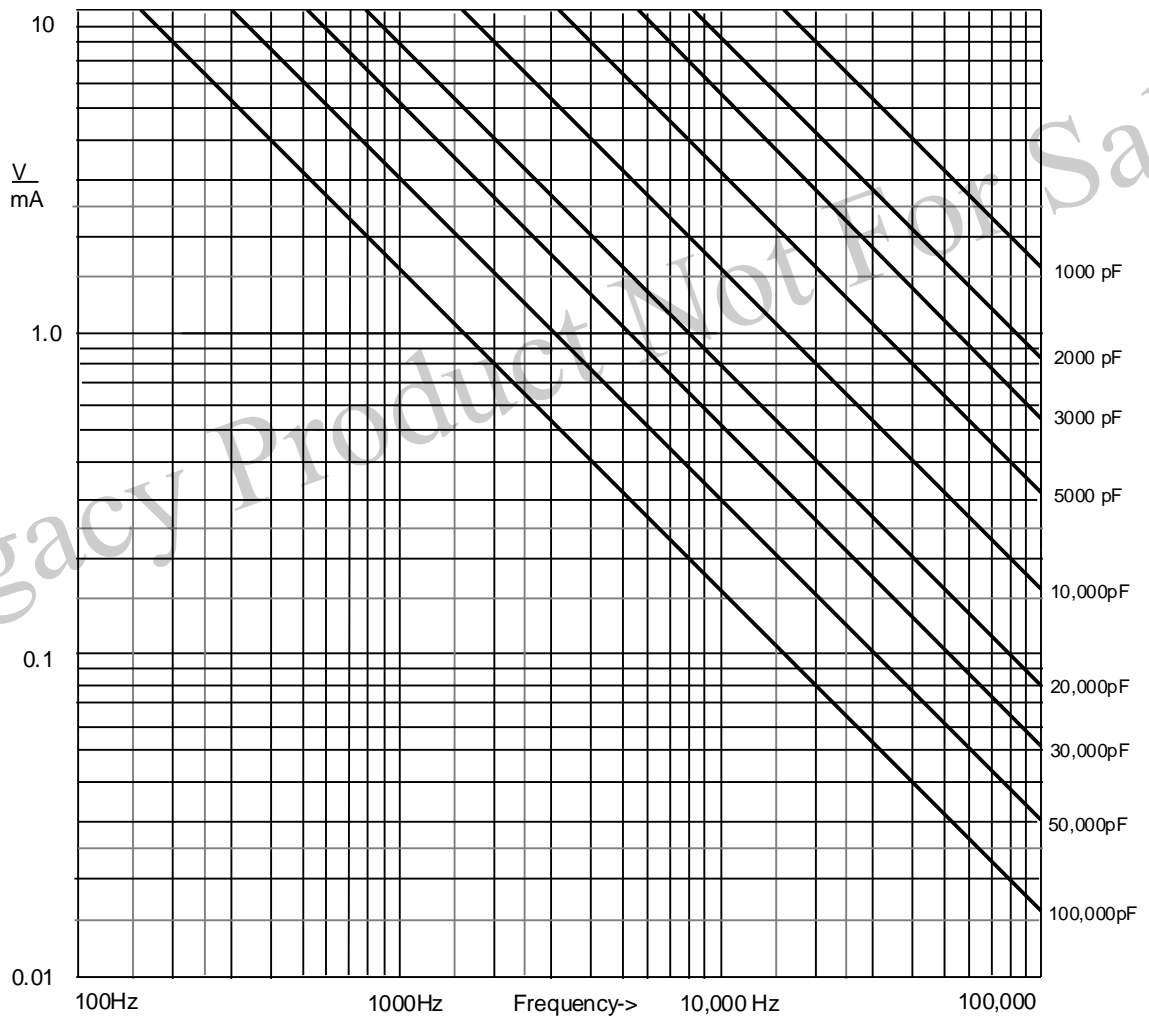

Figure A-3: RCC/ISOTRON Frequency Response Nomograph.

**ENDEVCO 6634C
INSTRUCTION MANUAL**

3. SIGNAL FILTERING (OPTIONAL)

The vibration signal can be filtered in the optional Model 35840A Filter.

The normalized acceleration signal is routed, when the optional Model 35840A is installed through the programmable internal filter to the output stage.

A. FILTER CHARACTERISTICS

The optional Model 35840A Programmable Filter provides adjustable band-pass settings. The high-pass and low-pass filters are 6-pole Butterworth, with 36 dB/octave (120 dB/decade) slope. The selected cutoff frequency is the frequency at which the gain is 3 dB lower than the midrange (reference) gain.

B. FILTER CALIBRATION

The Programmable Filter is set to the desired cutoff frequencies by digital command of the internal microcontroller from either front panel keyboard commands or from commands transmitted over the RS-232 bus (optional). The filter cutoff frequencies are set to the nominal value (approximately $\pm 15\%$) by the programming alone. To achieve the full accuracy of $\pm 5\%$, calibration should be performed. Calibration requires inputting a 5.000 V pk, 300.0 Hz sinewave signal at EXT-CAL input. During the overall calibration, the filter cutoff frequency offset is adjusted to within 5%.

The midband gain is not adjustable and is factory set to $1.00 \pm 0.5\%$.

C. EXTERNAL FILTER

To use the 6634C in the external filter mode, install filter between pin 2, "BB-OUT", and pin 13, "BB-IN", of the 25 pin Output connector. Move jumper W3 (internal to unit) from the 1-2 position to the 3-4 position. With W3 in the 3-4 position, either an external filter must be installed, or a jumper must be installed between pins 2 and 13 of the Output connector to complete the signal path. When using an external filter you are still able to use an internal filter with the "FILTER IN/OUT" key on the front panel.

The internal filter cal can be used to compensate for small errors in the external filter, but it is recommended to jumper the external filter out of the circuit before calibrating the internal filter.

4. ANALOG-TO-DIGITAL CONVERSION CIRCUITRY

An A/D conversion provides data for use by the microcontroller and for display on the front panel and outputting on the RS-232 bus.

The AC output signal from the range amplifier is converted to DC in an RMS-to-DC converter. The analog DC output signal is then converted to digital format in an internal analog-to-digital (A/D) converter. This digital data is used by the microcontroller to perform calibrations, to trigger the Alarm settings, to convert to engineering units for display on the front panel, and for outputting on the RS-232 bus in response to a data request.

The microcontroller also outputs digital data to a D/A converter which generates a DC output signal proportional to vibration level (in appropriately scaled units).

A simplified Digital Signal Flow Diagram, Figure A-4, describes the A/D and D/A signal processing inside the microcontroller.

**ENDEVCO 6634C
INSTRUCTION MANUAL**

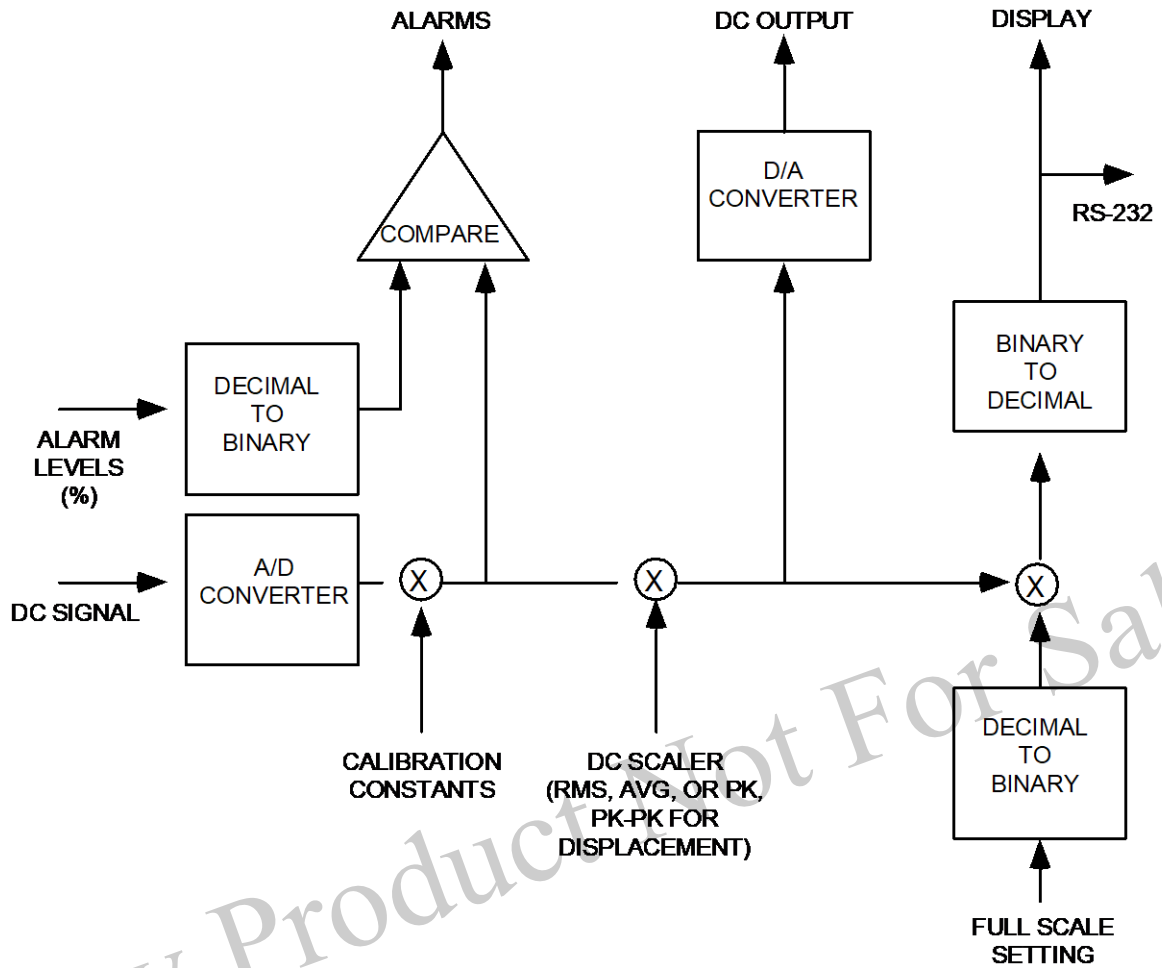

Figure A-4: Digital Signal Flow Diagram

5. PHASE RESPONSE FOR 6634C

The 6634C Phase Response for Broadband output, Acceleration output, Velocity output, and Displacement output are shown in Figure A-5. This phase response represents the output without the Signal Filtering option (Model 35840A).

ENDEVCO 6634C
INSTRUCTION MANUAL

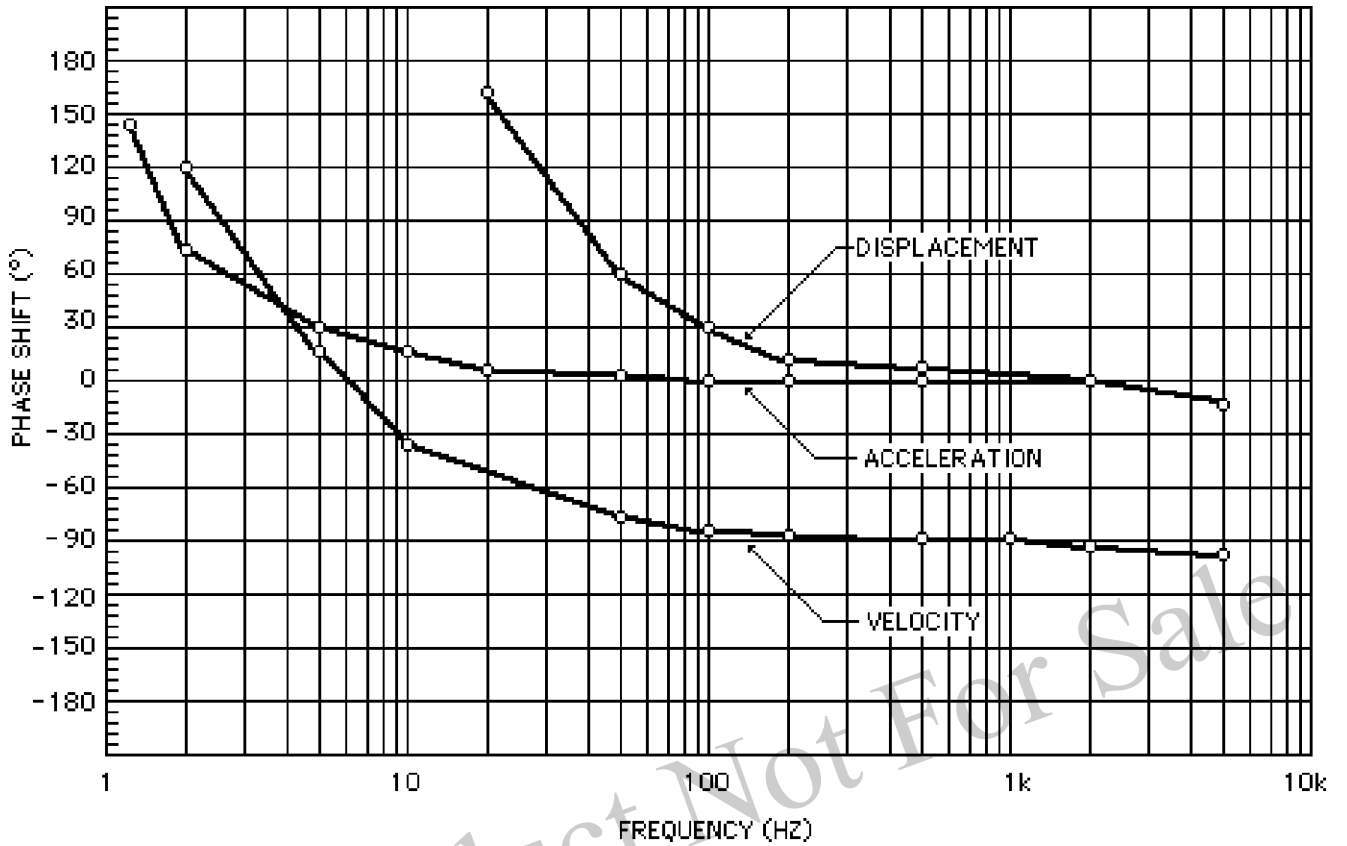

Figure A-5: Phase Response for 6634C

6. INTERFACE WITH 6634A INSTALLATIONS

The 6634C may be interfaced with old 6634A installations using an Endevco interface cable (Endevco Part Number 29685).